

# User Manual

# Mark S

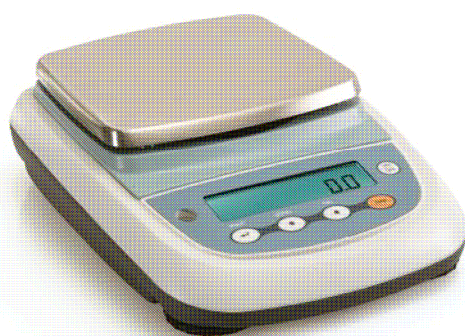

**Mark S**  
**Revision software RL\_6.xx and**  
**RL\_3.xx or higher**

## INDEX

<b>1</b>	<b>INSTALLATION INSTRUCTION .....</b>	<b>3</b>
<b>2</b>	<b>STORAGE.....</b>	<b>4</b>
<b>3</b>	<b>WEIGHING PAN ASSEMBLY .....</b>	<b>5</b>
<b>4</b>	<b>KEYPAD AND DISPLAY .....</b>	<b>6</b>
<b>5</b>	<b>OVERVIEW.....</b>	<b>7</b>
5.1	REAR AND BOTTOM PART OF BALANCE, MARK S MODELS .....	7
<b>6</b>	<b>WEIGHING .....</b>	<b>8</b>
6.1	STAND BY .....	8
6.2	SIMPLE WEIGHING .....	8
<b>7</b>	<b>CALIBRATION .....</b>	<b>9</b>
7.1	EXTERNAL CALIBRATION BALANCES .....	9
<b>8</b>	<b>TARE FUNCTION .....</b>	<b>11</b>
8.1	MANUAL TARE FUNCTION.....	12
8.2	OPTIONAL ALPHANUMERIC EXTERNAL KEYBOARD (CODE T201).....	13
<b>9</b>	<b>WEIGHING UNITS.....</b>	<b>15</b>
<b>10</b>	<b>PC COMMUNICATION SETTING .....</b>	<b>17</b>
<b>11</b>	<b>PRINTER SERIAL COMMUNICATION SELECTION.....</b>	<b>18</b>
<b>12</b>	<b>TRANSMISSION SPEED SELECTION.....</b>	<b>19</b>
<b>13</b>	<b>AUTOZERO FUNCTION .....</b>	<b>20</b>
<b>14</b>	<b>FILTERS SELECTION .....</b>	<b>21</b>
<b>15</b>	<b>STABILITY FUNCTION .....</b>	<b>22</b>
<b>16</b>	<b>DISPLAY CONTRAST REGULATION.....</b>	<b>23</b>
<b>17</b>	<b>BACKLIGHT SETUP .....</b>	<b>24</b>
<b>18</b>	<b>AUTO POWER-OFF FUNCTION.....</b>	<b>25</b>
<b>19</b>	<b>SELECTION OF WORKING MODE WITH TABLET.....</b>	<b>26</b>
<b>20</b>	<b>PIECECOUNTING FUNCTION .....</b>	<b>28</b>
20.1	VISUALIZATION OF TOTAL AND UNIT WEIGHT OF PIECES .....	29
20.2	MANUAL INSERTION OF THE UNIT AVERAGE WEIGHT .....	30
20.3	AUTOMATIC UPDATE OF UNIT WEIGHT .....	31
<b>21</b>	<b>DENSITY DETERMINATION OF A SOLID OR A LIQUID.....</b>	<b>32</b>
21.1	1 DENSITY DETERMINATION OF A SOLID .....	32
21.2	DENSITY DETERMINATION OF A LIQUID .....	34
<b>22</b>	<b>MAXIMUM LOAD DETERMINATION FUNCTION.....</b>	<b>36</b>
<b>23</b>	<b>PERCENTAGE WEIGHING FUNCTION.....</b>	<b>37</b>
23.1	MODE WITH WEIGHT REFERENCE.....	37
23.2	MODE WITH MANUAL INSERTION OF THE REFERENCE WEIGHT.....	38
<b>24</b>	<b>ANIMAL WEIGHING FUNCTION .....</b>	<b>40</b>

<b>25 TOTALIZING .....</b>	<b>41</b>
<b>26 THRESHOLD FUNCTION.....</b>	<b>43</b>
26.1 BOTH THRESHOLDS SET .....	44
26.2 LOWER THRESHOLD SET ONLY.....	44
26.3 HIGHER THRESHOLD SET ONLY .....	44
<b>27 RS232 INTERFACE FEATURES .....</b>	<b>45</b>
<b>28 WORKING WITH BATTERY.....</b>	<b>51</b>
<b>29 ERROR CODES.....</b>	<b>52</b>
<b>30 MAINTENANCE AND CARE.....</b>	<b>53</b>
<b>31 QUICK GUIDE TO BALANCE PARAMETERS SETUP .....</b>	<b>54</b>
<b>32 QUICK GUIDE TO THE USE OF THE BALANCE PROGRAMS .....</b>	<b>55</b>
<b>33 BALANCE TECHNICAL FEATURES.....</b>	<b>56</b>
<b>34 WARRANTY .....</b>	<b>57</b>
<b>35 EQUIPMENT DISPOSAL.....</b>	<b>57</b>

# 1 Installation instruction



## WARNING:

Please follow carefully these steps for installing and use the new balance before starting your work routine. A way of use of the instrument different from this user manual will not guarantee the instrument's safety anymore.

- **Remove** the balance and accessories from the carton and check for any visible damage of the instrument.
- **Do not install** the balance in a place with air flows, heavy thermic changes and vibrations.
- **Do not use** the balance in blast risk environment.
- **The humidity rate** of the balance environment must be between 45% and 75%

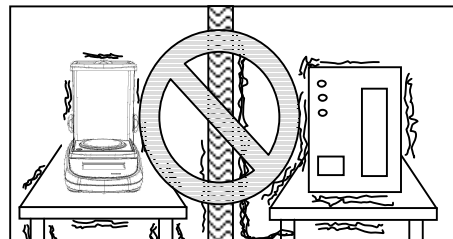
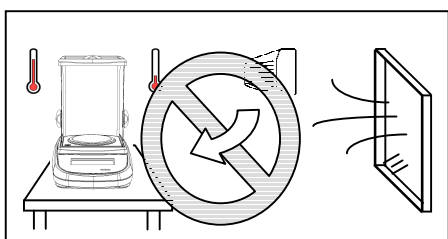

- **Place** the weighing pan and the support pan on the balance (see par. 3).
- **Level** the balance using the level bubble and levelling feet located underneath the case

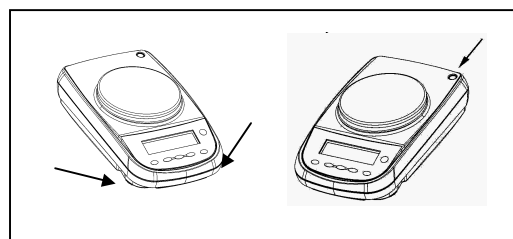
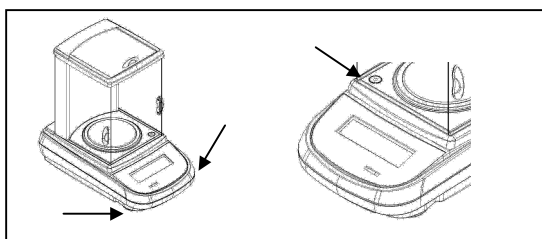

- **Connect** power supply to connector 2 located on the rear panel of the unit (see par.5).
- **Insert** power unit into AC outlet, **which shall be easily accessible**; after few seconds the balance will automatically switch on.

- **Wait 30 minutes from switch on** and then calibrate the balance using the appropriate mass, following the instructions (par.7)
- **Calibrate** again the balance every time it's moved to another place
- **Check** the balance calibration periodically.
- **We recommend** not to drop heavy objects on balance pan, in order to avoid damages.
- **Assistance service** must be effected by specialized staff and the spare parts used must be original. Therefore, it is necessary to apply to the reseller who sold the equipment.

## 2 Storage





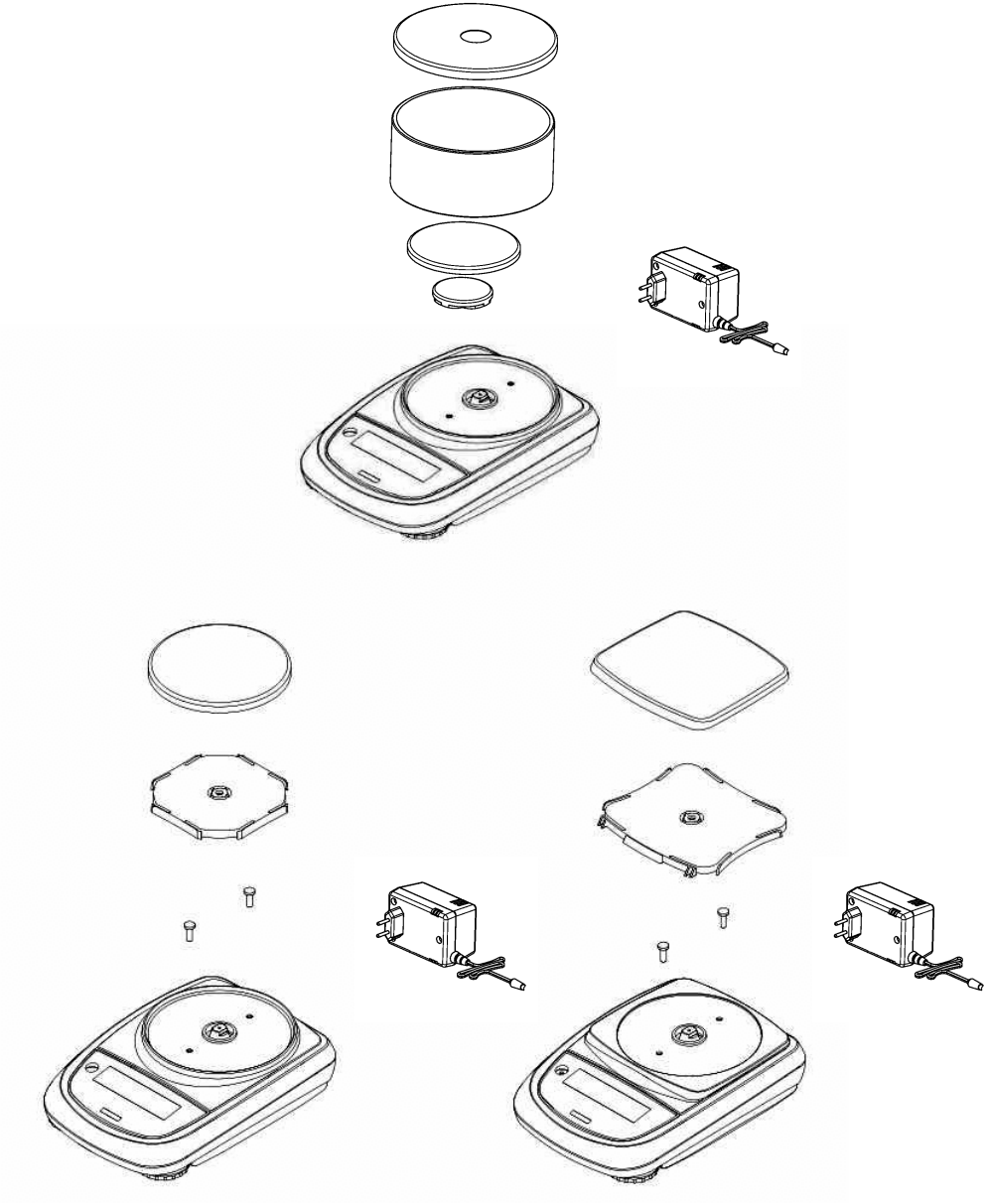



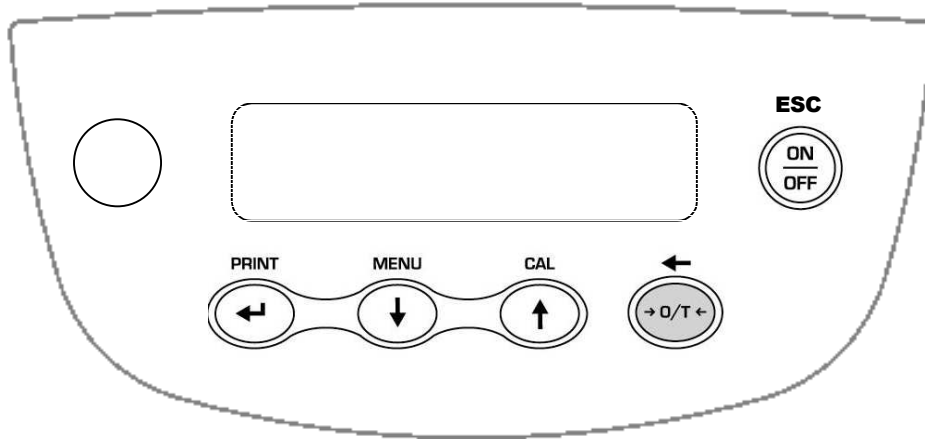



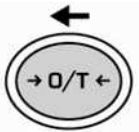

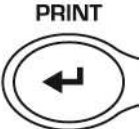
- **Storage temperature:** +5 °C...+40°C
- **Storage humidity** 45% - 75%.
- **Keep package** in the case the balance should be sent back to the factory for service. Disconnect the cables and the accessories for avoiding damages during transportation.
- **Do not place** the balance in extreme temperature and humidity condition and avoid the balance to take strong hit.

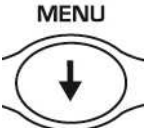
### 3 Weighing pan assembly

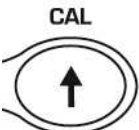

## 4 Keypad and display



	Standby (OFF) or power on (ON).		Stability indicator
	TARE or zero button.		Zero indicator
	Selection CONFIRM or SEND data to printer.		Percentage weighing
	Balance setup MENU button.		Piece counting
	Balance CALIBRATION button.		Battery charge indicator
			Insert data mode
			Upper threshold
			Lower threshold
			Density measure mode
			Measure unit
			<b>ozt, lb, GN, dwt, Kg, mg</b>

## 5 Overview

### 5.1 Rear and bottom part of balance, Mark S models

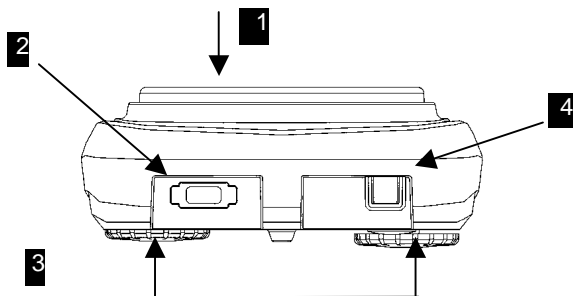

Fig.1

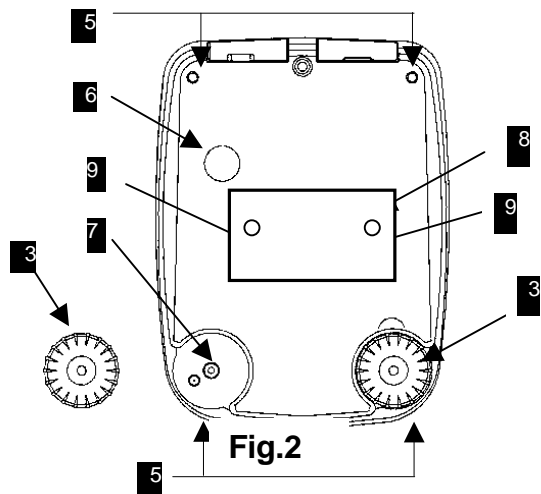

Fig.2

Fig.1 and 2 : Rear and bottom part of balance	
1	Weighing pan
2	9 poles (pins) connector (pin) female for RS232 interface/PC/printer/Keyboard
3	Adjustable feet
4	Power supply connector
5	Balance closing screws
6	Hook for under balance weighing ( <b>Note:</b> remove the cap to find the hook)
7	RESET button (Press with a sharp object inside the hole to reset the instrument if necessary)
8	Battery
9	Viti chiusura vano batterie



## 6 Weighing

After having connected the balance to AC outlet, it will perform an internal circuits test, after that the balance will set itself in stand-by mode.



### 6.1 Stand By

From “**STAND BY**” mode:

- Press **ON/OFF** button to bring balance to work conditions.
- Press again **ON/OFF** button to return to “**STAND BY**” condition.

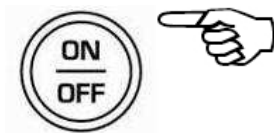

### 6.2 Simple weighing

Load the sample to weigh on the pan and read the value on display as soon as the stability symbol ✱ (*star*) appears



## 7 Calibration

Electronic balances take mass measurements making use of gravity (g). Difference of latitude in geographic areas and altitude will vary gravity acceleration value (g). Therefore, for accurate measurements, the balance must be adjusted to the local environment. This adjustment is accomplished by calibration function.

### 7.1 External calibration balances

Calibration is accomplished by pressing **CAL** button.

1. Press **CAL** button when pan is empty, dashes are displayed on the display.

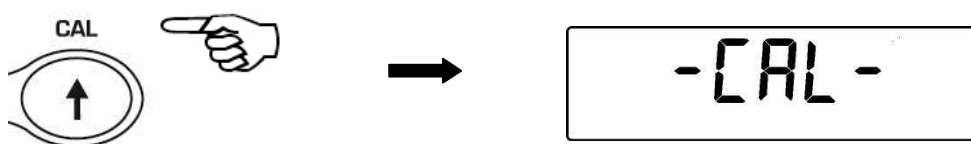

2. When calibration weight value starts to flash, load the weight on the pan.

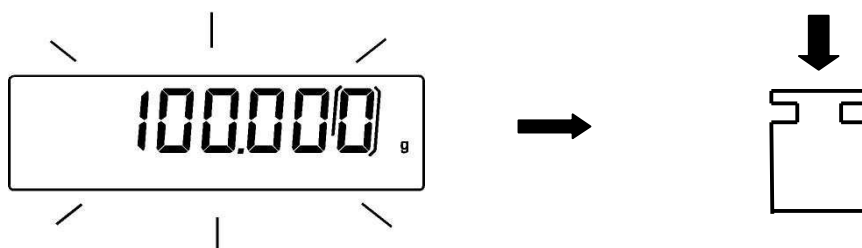

3. The display will stop flashing, indicating calibration weight value.  
Once the calibration is effected will be shown the value of the calibrated weight and the current unit of measure.
4. Unload calibration weight from the pan.  
The balance is ready for weighing operations.

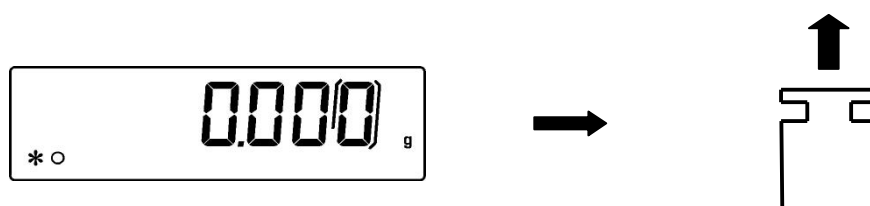

**NOTE:** if there is interference during calibration process, an error message will be displayed.

Moreover, it is possible to calibrate the balance with a calibration weight higher than the one set by default:

1. Press and keep **CAL** button pressed with empty pan until the acoustic alarm stops, then release the button. On display it will be visualized the string **"-CAL-"**, followed by flashing string **"LOAD"**.

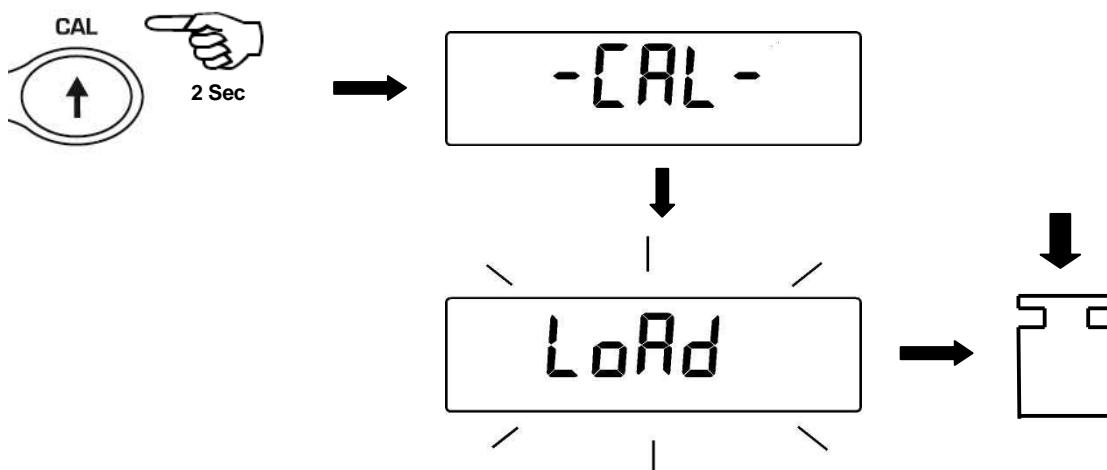

2. Load on the pan a weight equal higher or lower than default calibration weight; the balance will recognize it as valid weight if equal or higher than calibration weight as long as it is a whole number in comparison with the most meaningful digit of calibration weight .

*e.g.: if calibration weight is 200g, it will be possible to calibrate the balance with values from 100g 200g, 300g, 400g up to the highest limit of balance weighing range.*

The message **"LOAD"** on display will stop flashing. Once calibration has been effected, the value of calibrated weight will be displayed.

3. Unload calibration weight. The balance is ready for weighing operations.

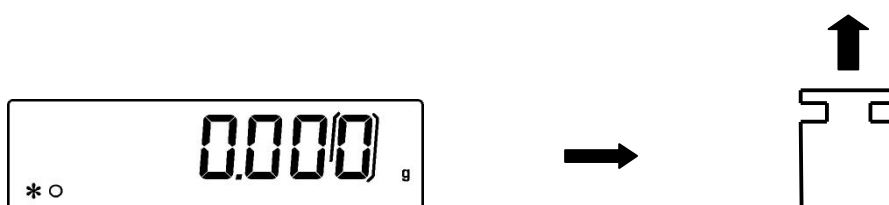

**NOTE: if there is an interference during calibration process, an error message will be displayed.**

## 8 Tare function

1. Load the container on the pan. The display will show the weight.

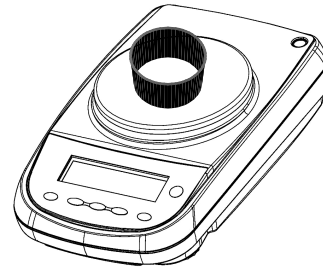

2. Press **O/T** button. "O-t" string will be displayed



3. After reaching stability, the value "0.000" will be displayed. If the stability is not reached (due to air flows or vibrations or other disturbs) the dashes will remain displayed.



4. Load the objects to weigh in the container. Read net weight value on display.

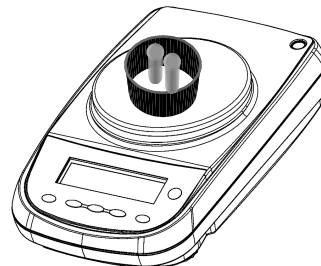

## 8.1 Manual tare function

This function allow to insert manually the tare values.

1. Press and keep pressed the **O/T** key whit no objects on the weighing pan until the beep alarm stops, then release the key.
2. Will be shown on the display the following string:

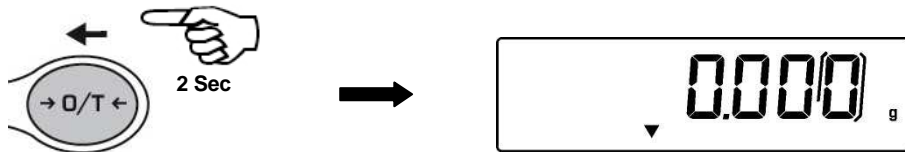

3. Insert now the desired tare value using the keys **CAL** and **MENU** for increase or decrease the value, and press the **O/T** key for skip to the following digit. During the value insert mode, if keep pressed the **O/T** key is possible to delete the inserted value.

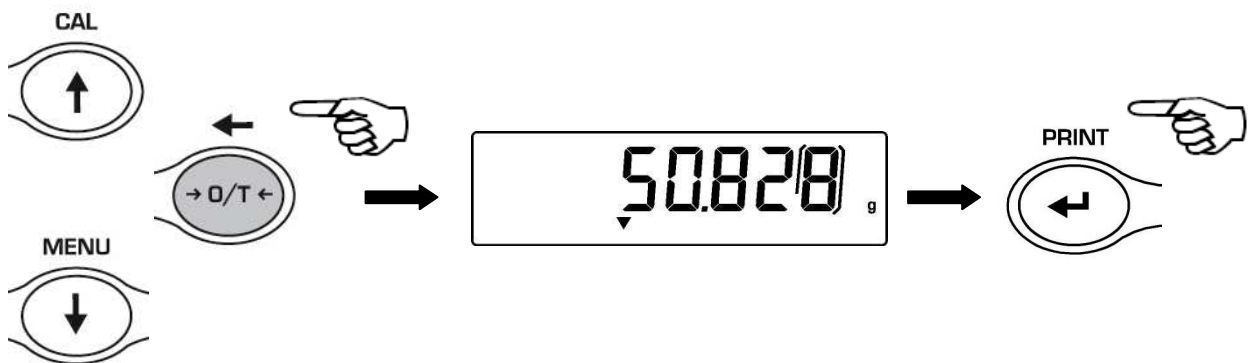

4. Press **PRINT** key to confirm the value inserted.

## 8.2 Optional alphanumeric external keyboard (code T201)

If you have the optional external alphanumeric keyboard, then it is possible to perform tare also by pressing the **TARE/DELETE** button of this keyboard, in the same way as previously described.

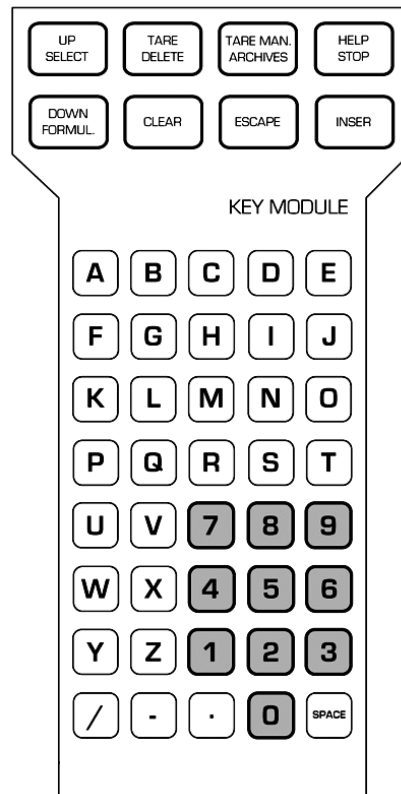

It's also possible to manually insert a known tare value by the keypad.

1. Press **TARE MAN** button on the alphanumeric keyboard. An arrow will appear on the balance display along with the previous value of manual tare, if one has been inserted before.

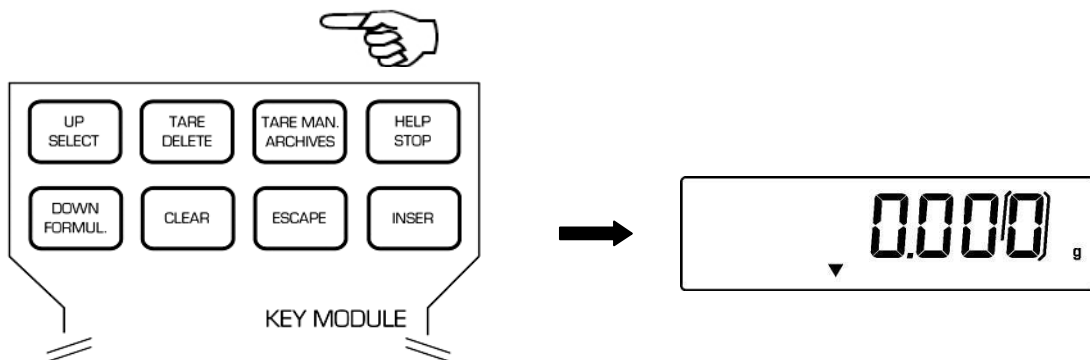

2. Press **CLEAR** to set at zero the previous value (if any) then insert the new value using the alphanumeric buttons placed on the bottom part of alphanumeric keyboard.



3. Press **INSER** to confirm.
4. Press **ESCAPE** button to escape from tare condition.

To set to zero the value of the manual tare inserted by means of alphanumeric keyboard, effect a normal operation of tare by pressing **O/T** button of the balance or with **TARE/DELETE** button placed on the optional alphanumeric keyboard.

## 9 Weighing units

It is possible to select the weight unit that balance will use to display weight.

1. From display zero condition press and keep pressed the **MENU** button until the acoustic alarm is over, then release the button. The message “unitS” will be displayed then press **PRINT** to confirm.

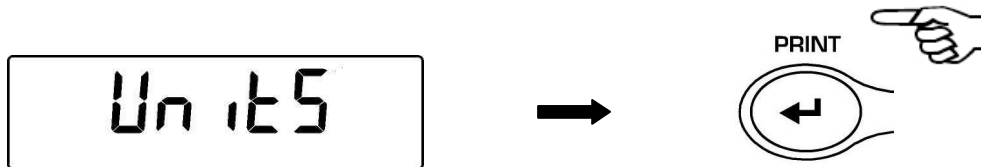

2. It will be displayed “GRAM” unit. Pressing now the **MENU** or **CAL** button, it will be possible to scroll forward or backward the weight units menu.



3. Press **PRINT** button to confirm or **MENU** button to shift to the other weight unit.

The diagram shows two circular buttons. The top button is labeled "CAL" and has an upward-pointing arrow. A hand points to it. Below it is a vertical line with an upward arrow. The bottom button is labeled "MENU" and has a downward-pointing arrow. A hand points to it. Below it is a vertical line with a downward arrow.

SYMBOL	UNIT	CONVERSION FACTOR 1g =
GRAM	GRAM	1.
CARAT	CARAT	5.
OUNCE	OUNCE	0.035273962
POUND	POUND	0.0022046226
PENN.	PENNYWEIGHTS	0.643014931
ONCETR.	ONCE TROY	0.032150747
GRANO	GRAIN	15.43235835
Tael HON	HONG KONG Tael	0.02671725
* Tael SGP	SYNGAPORE Tael	0.02646063
* Tael ROC	R.O.C. Tael	0.02666666
* MOMME	MOMME	0.2667
M 10	x 10	10.
M 100	x 100	100.

A circular button labeled "PRINT" with a hand pointing to it. A small arrow inside the button indicates a leftward press. A large L-shaped arrow points from the top left towards the button.



4. After having selected the desired weight unit, press the **MENU** button to go to next parameter or **CAL** button to return to previous.
5. To escape from parameters setup menu, press the **MENU** button until the acoustic alarm is over, then release the button. The balance returns to normal weighing conditions.

\* The unit of measure with the star (\*) are not available in the balances with the software for paper grammage. In these models is possible to set from the menu of the units of measure the multiply factor of the weight "M 10" or "M 100". For visualizing the m<sup>2</sup> weight, select the M 100 multiply factor (as described at par.9) and load on the pan a 10x10 cm piece of paper.

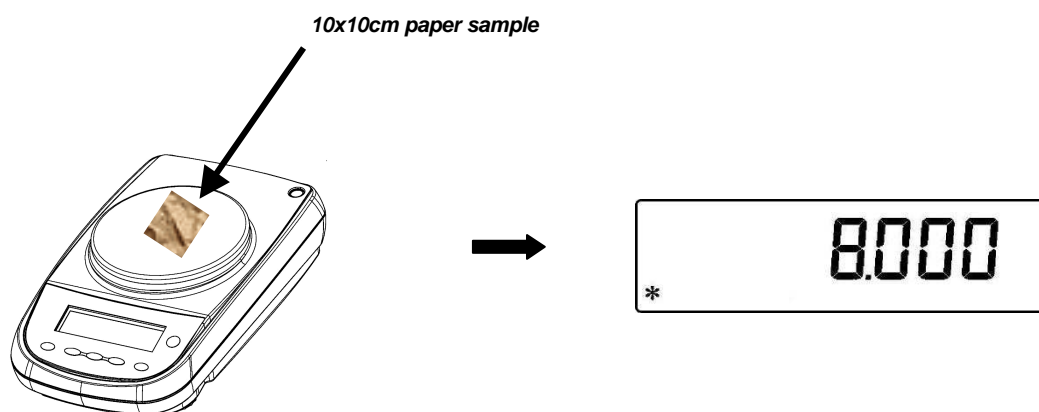

## 10 PC communication setting

Connect the balance to PC with proper cable (not included) (par.0)

1. From zero display condition press and keep pressed the **MENU** button until the acoustic alarm is over, then release the button. It will be displayed the string “unitS”, then press the **MENU** button until it is displayed “PC-PRTR” message then confirm by pressing **PRINT** button.

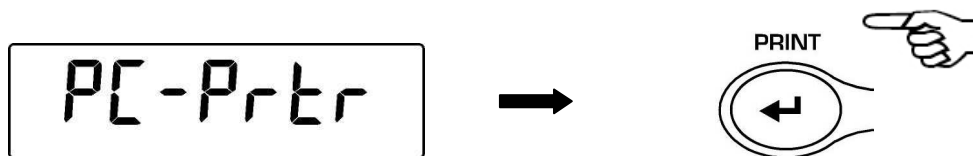

2. Press the **MENU** button until the “PC cont” is displayed to choose continuous print or “PC CMd” to choose print to PC at user command, then press the **PRINT** button to confirm the choice.

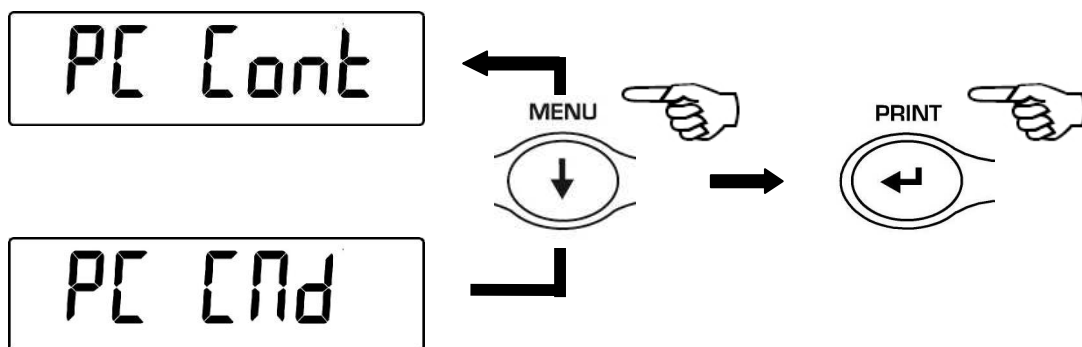

3. After having selected the desired transmission mode, press the **MENU** button to go to next parameter or the **CAL** button to go to previous.
4. To escape from parameters setup menu, press the **MENU** button until the acoustic alarm is over, then release the button. The balance returns to normal weighing conditions.
5. The balance returns to normal weighing conditions sending the data continuously or at user command.



**NOTE: select speed transmission (par. 0)**

## 11 Printer serial communication selection

Connect the balance to the printer using the proper cable (par. 24)

1. From zero condition on display, press and keep pressed the **MENU** button until the acoustic alarm is over, then release the button. The message “**unitS**” will be displayed, then press **MENU** until you read the message “**PC-PRTR**” on display and confirm pressing **PRINT** button



2. To select the data print mode, press **MENU** until the message “**PRINT**” is displayed.
3. Press **PRINT** to confirm.

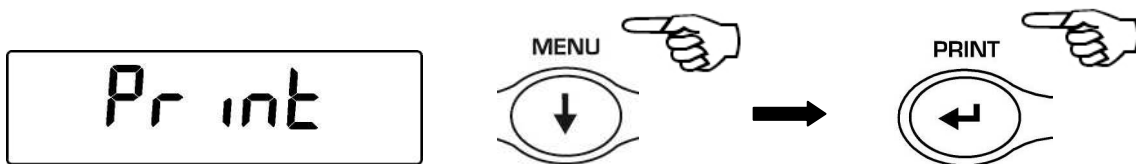

4. After having selected the data print mode, press **MENU** button to go to next parameter or **CAL** button to go to previous one.
5. To escape from parameters setup menu, press **MENU** button until the acoustic alarm is over, then release the button. The balance returns to normal weighing conditions, ready to transmit data each time the **PRINT** button is pressed.



**NOTE: select speed transmission (par.0)**

## 12 Transmission speed selection

1. From zero condition on display, press and keep pressed the **MENU** button until the acoustic alarm is over, then release the button. The message “**unitS**” is displayed, then press **MENU** button until the message “**BAUD RT**” is displayed and confirm by pressing the **PRINT** button.



2. Select serial data transmission speed (1200-2400-4800-9600 baud). Pressing **MENU** or **CAL** buttons it will be possible to scroll forward or backward through the different transmission speeds, then confirm your choice by pressing **PRINT** button.

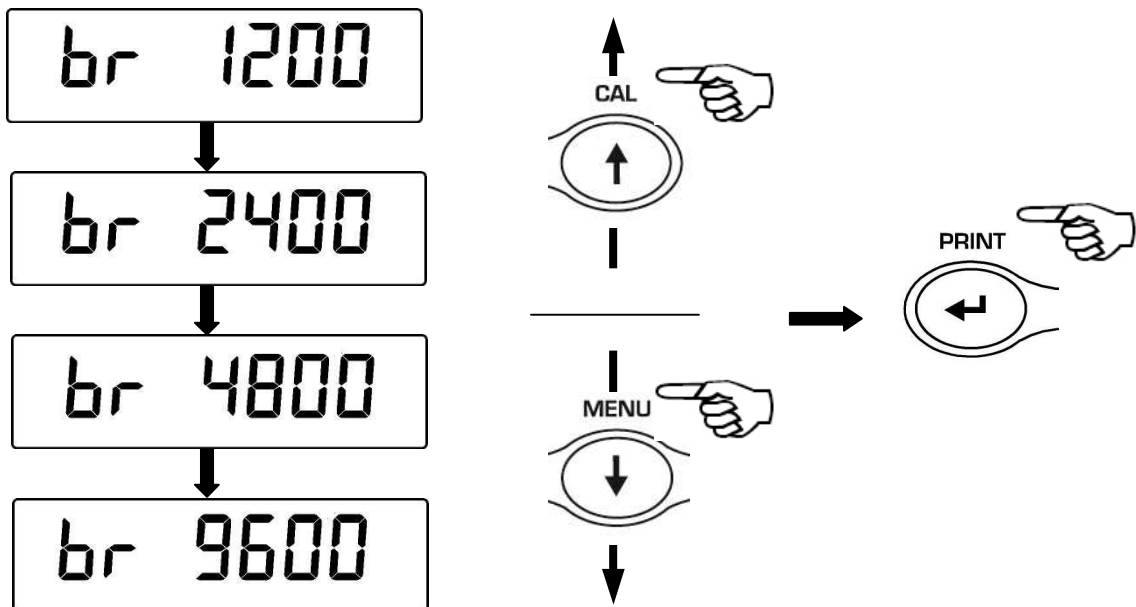

3. After having selected the transmission speed you wish, press the **MENU** button to go to next parameter or **CAL** button to go to previous one.
4. To escape from parameters setup menu, press the **MENU** button until the acoustic alarm is over, then release the button.
5. The balance will return to standard weighing conditions.



## 13 Autozero function

Autozero is an automatic correction of a possible zero drift.

- **Au0 OFF** = autozero disabled
- **Au0 1** = soft autozero
- **Au0 2** = medium autozero
- **Au0 3** = heavy autozero
- **Au0 3E** = heavy autozero over all range

1. From zero condition on display, press and keep pressed the **MENU** button until the acoustic alarm is over, then release the button. The message “**unitS**” is displayed, then press **MENU** button until the message “**AUTO 0**” is displayed, then press **PRINT** to confirm.

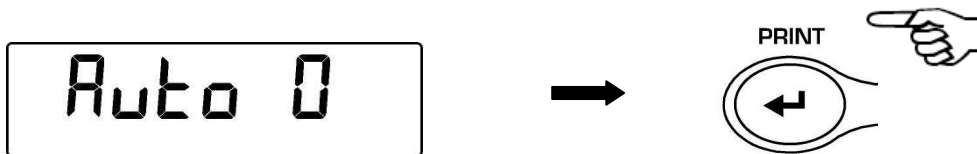

2. Pressing **MENU** or **CAL** button it will be possible to scroll forward or backward through the different autozero levels, select the one you wish and confirm it by pressing the **PRINT** button.

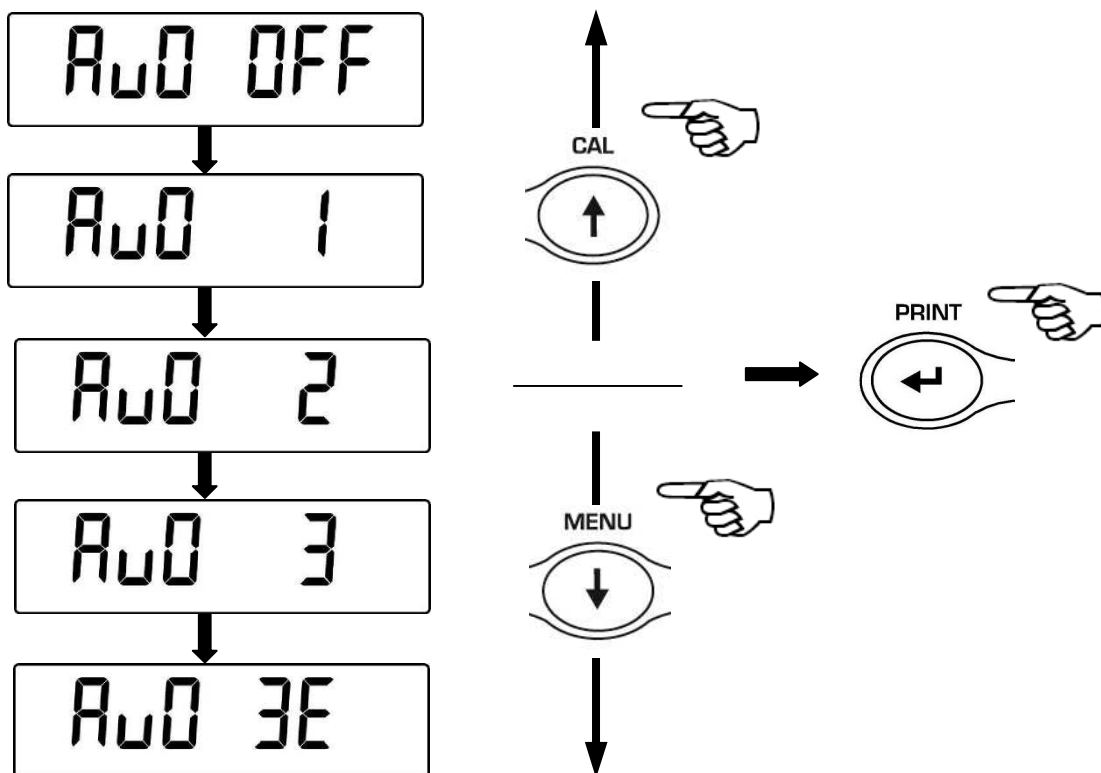

3. After having selected the autozero level you wish, press the **MENU** button to go to next parameter or **CAL** button to go to previous one.
4. To escape from parameters setup menu, press the **MENU** button until the acoustic alarm is over, then release the button.
5. The balance will return to standard weighing conditions

## 14 Filters selection

It is possible to adapt the balance to the different environment conditions thanks to the selection of three filters:

- **FILTER 1:** proportion of ingredients condition
- **FILTER 2:** stable conditions
- **FILTER 3:** unstable conditions

1. From zero condition on display, press and keep pressed the **MENU** button until the acoustic alarm is over, then release the button. The message “**unitS**” is displayed, then press **MENU** button until the message “**FILTER**” is displayed then confirm it by pressing the **PRINT** button.

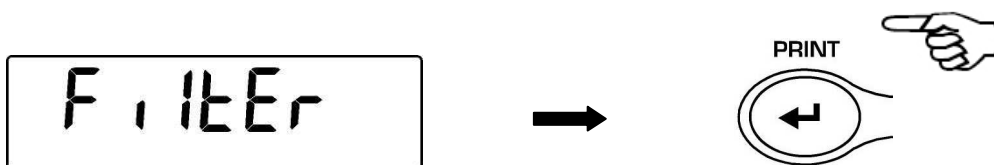

2. Pressing **MENU** or **CAL** button it will be possible to scroll forward or backward the different filtering levels, select the one you wish and then confirm it by pressing the **PRINT** button

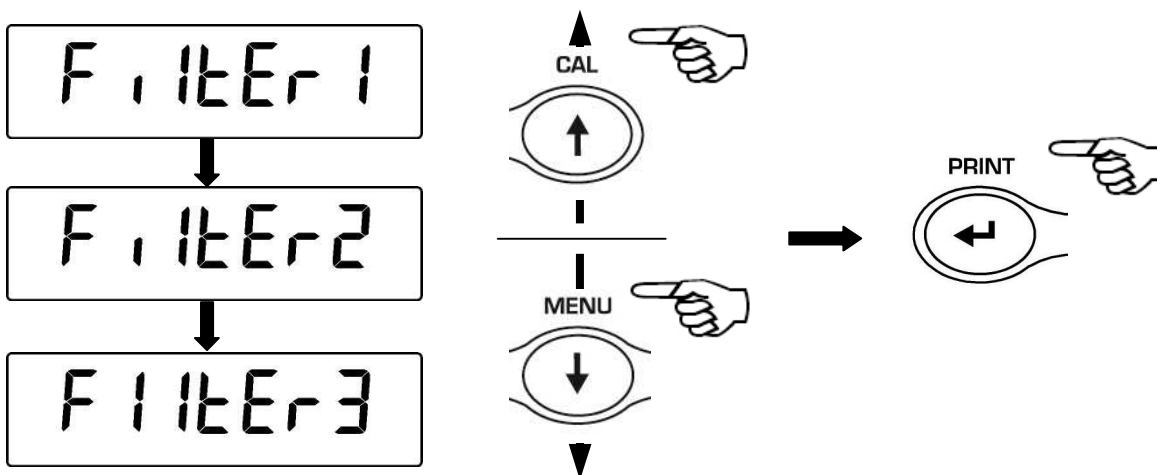

3. After having selected the filtering level you wish, press the **MENU** button to go to next parameter or **CAL** to go to previous one.
4. To escape from parameters setup menu, press the **MENU** button until the acoustic alarm is over, then release the button.
5. The balance will return to standard weighing conditions.



**NOTE:** It is suggested to use FILTER 1 when proportion of ingredients must be performed

## 15 Stability function

The stability symbol is displayed when the weight is stable inside a defined range

- **STAB 1** = for stable environments
- **STAB 2** = for not so stable environments
- **STAB 3** = for unstable environments

1. From zero condition on display, press and keep pressed the **MENU** button until the acoustic alarm is over, then release the button. The message “**unitS**” is displayed, then press **MENU** button until the message “**StAbiL**” is displayed, then confirm this by pressing the **PRINT** button.
2. Pressing **MENU** or **CAL** button it will be possible to scroll forward or backward the different stability levels, select the one you wish and then confirm it by pressing the **PRINT** button.

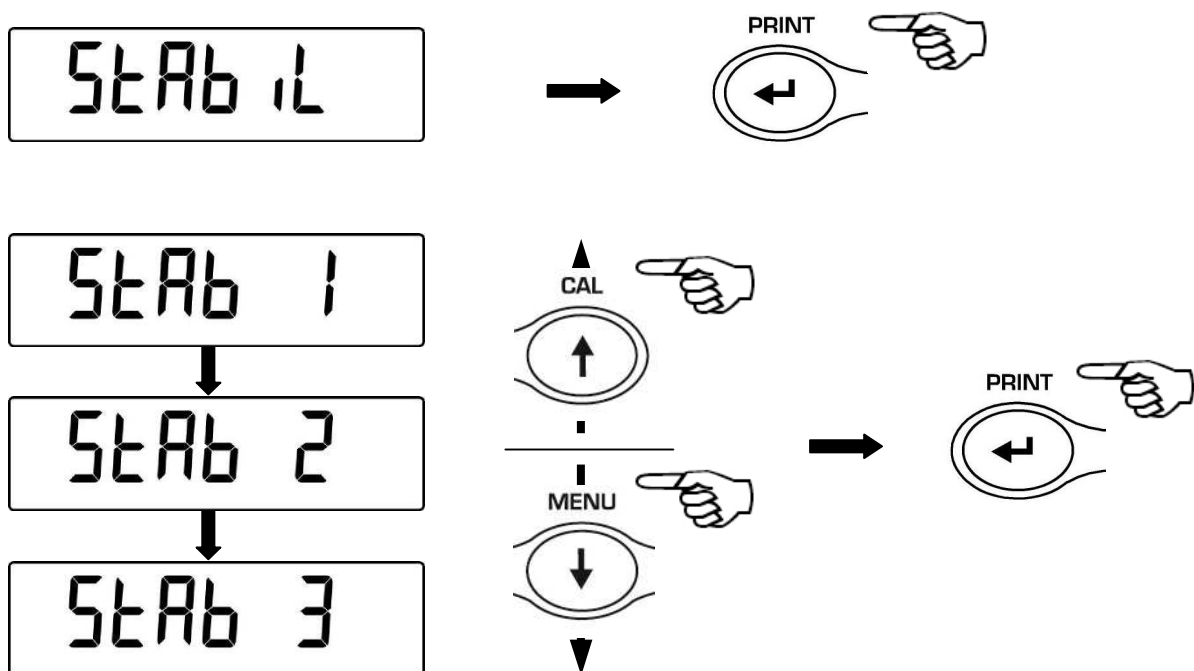

3. After having selected the stability level you wish, press the **MENU** button to go to next parameter or the **CAL** button to go to previous one.
4. To escape from parameters setup menu, press the **MENU** button until the acoustic alarm is over, then release the button.
5. The balance returns to normal weighing conditions.



## 16 Display Contrast regulation

It is possible to regulate the contrast level of display to have a comfortable view of the indication at different angles of usage.

There are 15 different levels of regulation:

1. From zero condition on display, press and keep pressed the **MENU** button until the acoustic signal gets mute, then release the button. The message “**unitS**” is visualized, now press the **MENU** button repeatedly until the message “**contr**” is displayed and confirm this by pressing the **PRINT** button



2. Now, pressing the buttons **MENU** or **CAL** it is possible to increment or decrement the level of the display contrast; select the one desired and confirm by pressing the **PRINT** button.

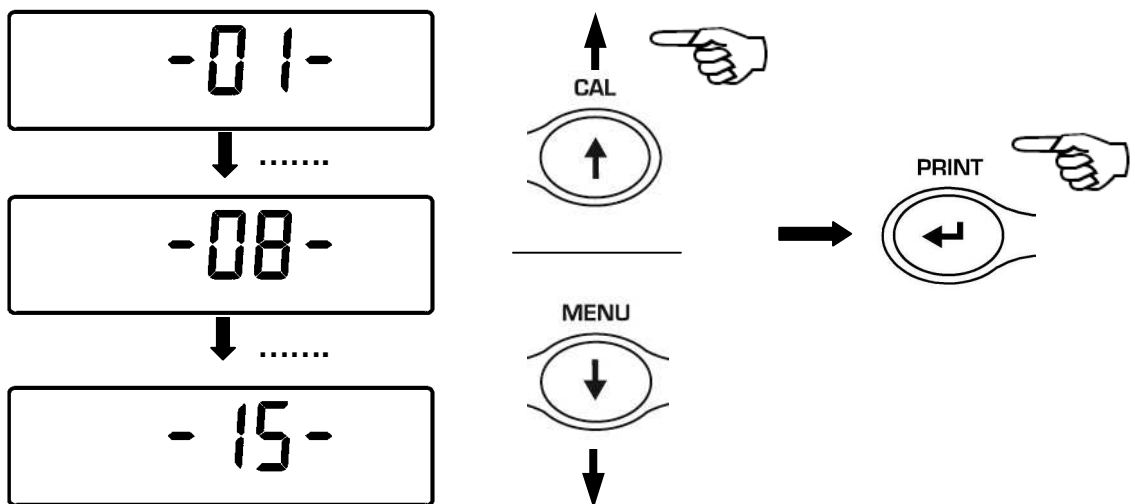

3. After you have confirmed the contrast level desired, press the **MENU** button to go to the next parameter or the **CAL** button to go to previous one.
4. To escape from parameters setup menu, press the **MENU** button until the acoustic alarm gets mute, then release the button.
5. The balance returns to normal weighing mode





## 17 Backlight setup

The balance display is equipped with backlight to make the indication more visible also during low light conditions.

There are 3 working modes:

- **ON** = light always switched ON
- **OFF** = backlight always switched OFF
- **AUTO** = backlight automatically switched on during weighing operations

1. From zero condition on display, press and keep pressed the **MENU** button until the acoustic alarm is over, then release the button. The message “**unitS**” is displayed, then press **MENU** button until the message “**bLt**”, then press the **PRINT** button to confirm this.



2. Pressing **MENU** or **CAL** button it will be possible to scroll forward or backward the different working modes, select the one you wish and then confirm it by pressing the **PRINT** button

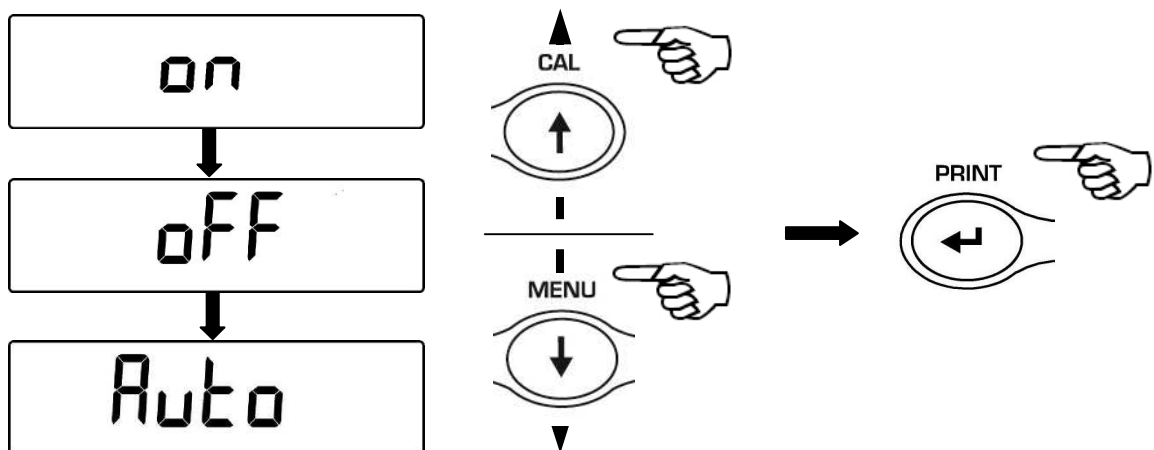

3. After having selected the backlight working mode you wish, press the **MENU** button to go to next parameter or the **CAL** button to go to previous one.
4. To escape from parameters setup menu, press the **MENU** button until the acoustic alarm is over, then release the button.
5. The balance returns to normal weighing conditions.



## 18 Auto Power-off function

This function allows to activate the automatic power-off of the balance after a defined balance idle-time. There are 4 auto power-off modes:

- **disab** = Auto power-off disabled
- **2 Min** = Auto power-off after 2 minutes of idle time
- **5 Min** = **Auto power-off after 5 minutes of idle time**
- **15 Min** = **Auto power-off after 15 minutes of idle time**

1. From zero condition on display, press and keep pressed the **MENU** button until the acoustic alarm is over, then release the button. The message “**unitS**” is displayed, then press **MENU** button until the message “**tiME oFF**” then confirm by pressing the **PRINT** button.



2. Pressing **MENU** or **CAL** button it will be possible to scroll forward or backward the different auto power-off modes, select the one you wish and then confirm it by pressing the **PRINT** button

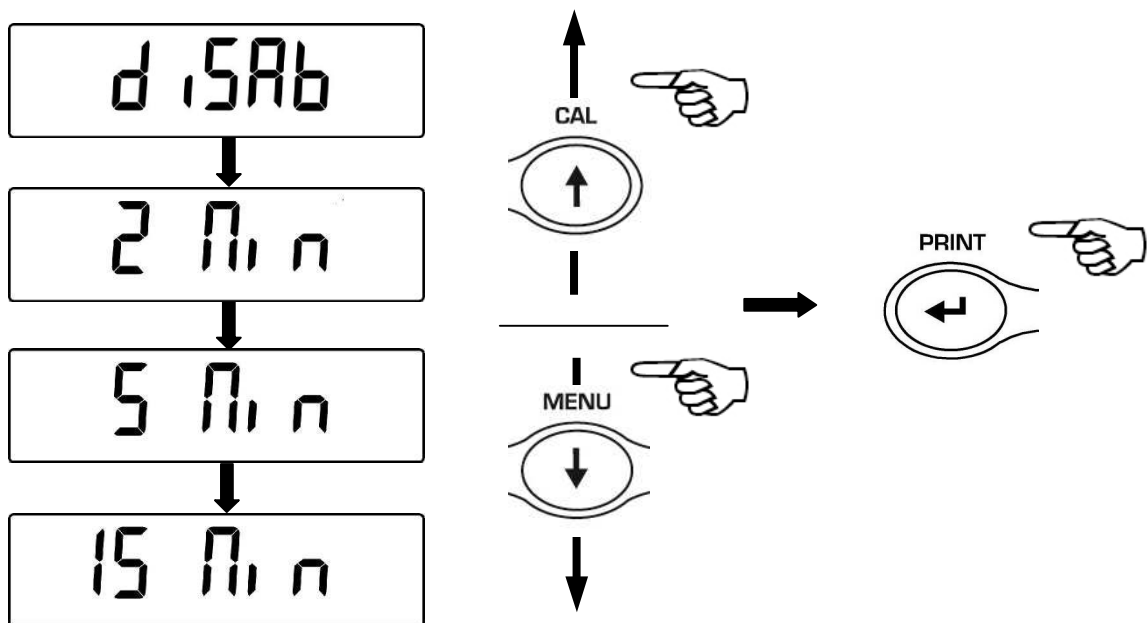

3. After having selected the auto power-off mode you wish, press the **MENU** button to go to next parameter or the **CAL** button to go to previous one.
4. To escape from parameters setup menu, press the **MENU** button until the acoustic alarm is over, then release the button.
5. The balance returns to normal weighing conditions.

## 19 Selection of working mode with Tablet

NOT available for balance version software RL 3.xx

Using the appropriate connection box, connect the tablet to the serial output of the balance.

1. From condition of zero on display, press and hold the **MENU** button until the acoustic signal is over, then release the button. The message “**unitS**” is displayed, press the button **MENU** until the message “**TBL MODE**” is displayed and confirm pressing **PRINT** button

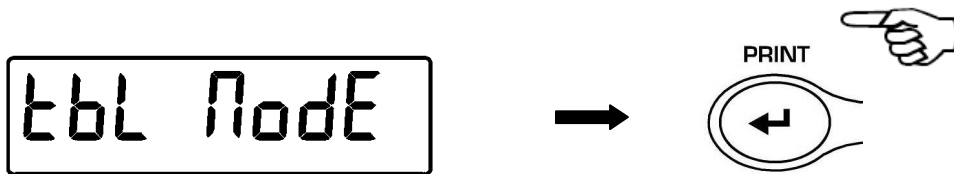

2. To choose the working mode with tablet, press the **MENU** button until you visualize the message “**TBL ON**”, then press **PRINT** to confirm

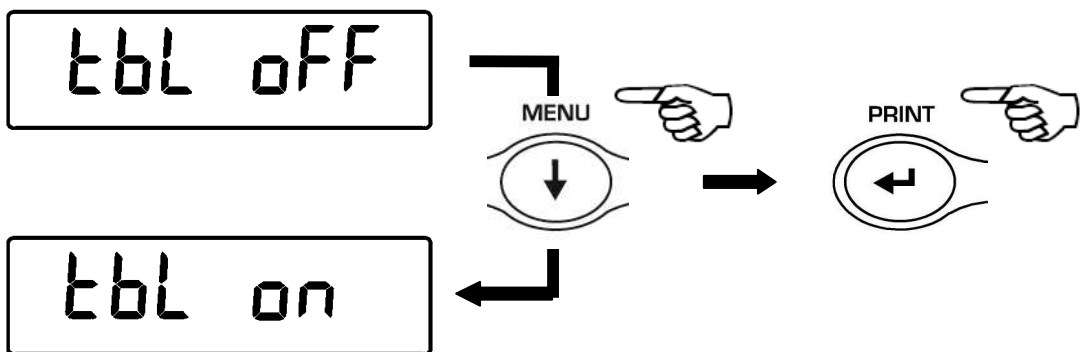

3. After you have chosen the mode “**TBL ON**” the balance will automatically restart and the message “**TABLET**” will appear on the display of balance. From this moment the interface device with the balance is the tablet.

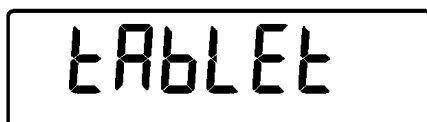

4. To escape from “**TABLET**” mode, press the **MENU** button , then **PRINT** button.

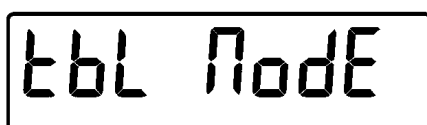

5. Press the **MENU** button until you visualize the message "**TBL OFF**", then press **PRINT** to confirm the selection.

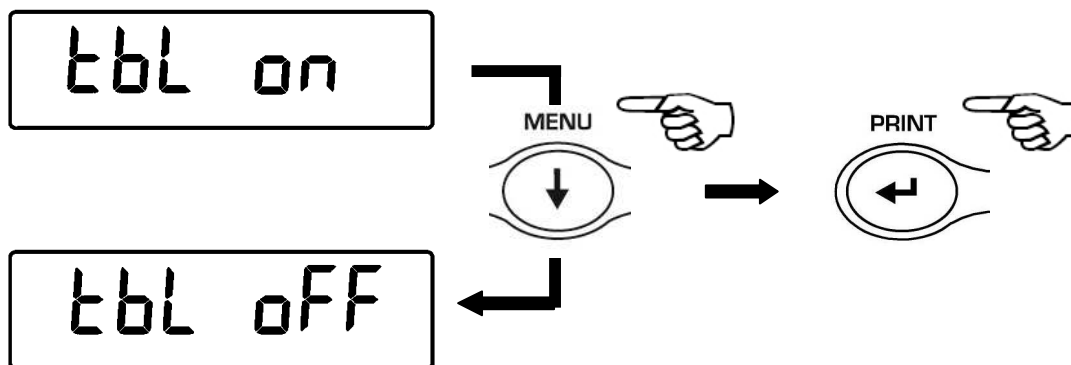

6. After you confirm with the **PRINT** button, the balance will restart automatically and will return to standard working mode.

## 20 Piececounting function

1. From zero condition on display, press **MENU** button until the message “Count “ is displayed then press the **PRINT** button to confirm



2. Select the number of pieces to put on the pan as sample by pressing **MENU** repeatedly to increase and **CAL** to decrease the number. Choice of the number of pieces (10, 25, 50, 100) depends from the weight of single pieces. If available, load the empty container first then press **PRINT** to confirm.



3. Load on the pan the number of pieces displayed on the balance display

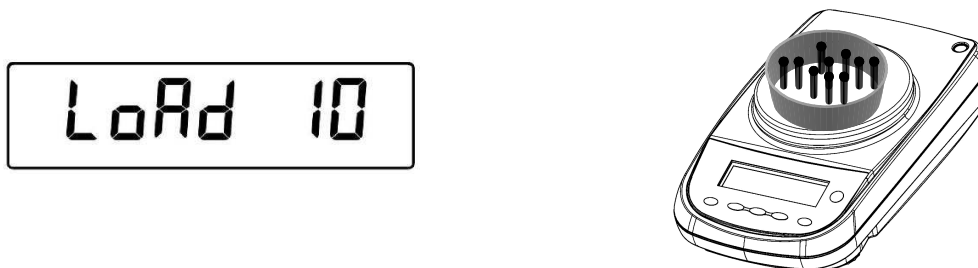

4. Press again the **PRINT** button and wait the weight to stabilize.

If the number of samples is enough (for example 10 as in figure), then this number will be displayed and it will be possible to go on by loading the pieces to count on the balance pan.

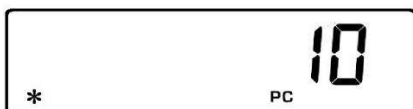

If the weight of the pieces to count is too low in comparison with balance resolution, then an error message will be displayed. In this case it is necessary to use a balance with higher resolution.

If the weight of samples is acceptable but not enough, then the message “**Add**” will be displayed.

Add a quantity of pieces so that to almost double the number read on display, then press the **PRINT** button

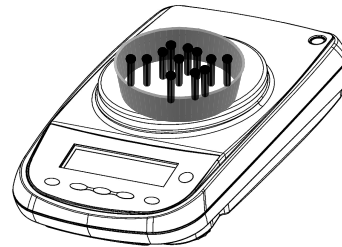

If the number of pieces is still not enough then the message “**Add SMP**” is displayed.

Add again a quantity of pieces so that to almost double the number you read on display

As soon as it is reached a sufficient number of pieces, this number is displayed and it will be possible to go on with count by loading the pieces count on the balance pan.



5. To escape from piececounting mode press the **ON/OFF** button and the balance returns to normal weighing conditions.

## 20.1 Visualization of total and unit weight of pieces

1. Press **MENU** button to pass from pieces number visualization to total weight visualization.

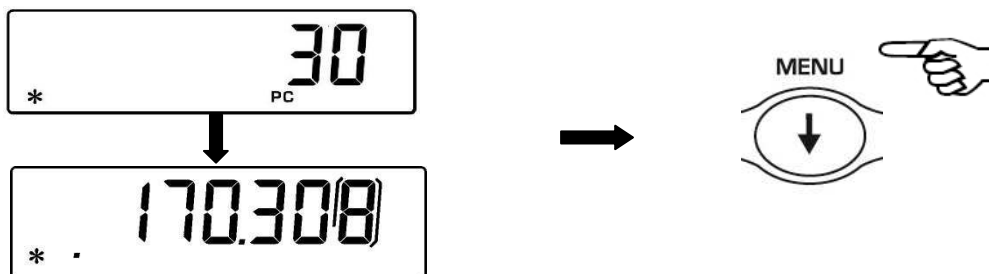

2. In order to display the weight of single piece from the total number of pieces press and keep pressed the **MENU** button until the acoustic alarm is over.
3. Press again the **MENU** button to display the number of pieces.

## 20.2 Manual insertion of the unit average weight

It is possible to insert the unit average weight of the sample, if known. In this way can be avoided the sampling of the units.

1. From zero condition on display, press the **MENU** button until the message “**Count**”, then press the **PRINT** button to confirm.  
Select **MANUAL** by pressing repeatedly the **MENU** button.

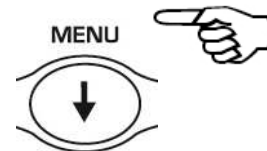

2. Press the **PRINT** button to confirm.



3. Insert the unit weight of a sample in grams using **CAL** and **MENU** buttons for increase and decrease the value and use the **O/T** button to skip to the others digits. For insert the For inserting the decimal point keep pressed the **CAL** button. Keeping pressed the **O/T** button is possible to delete the inserted value.

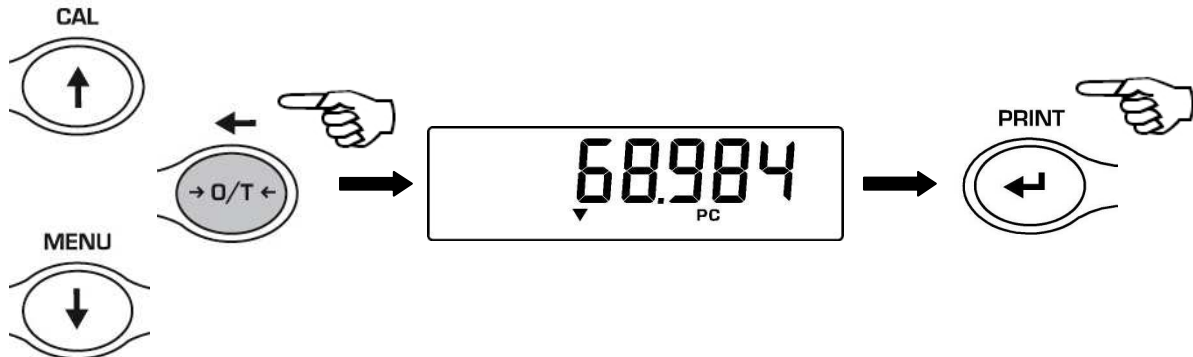

4. Press the **PRINT** button to confirm.  
If the inserted weight is 100 times lower than balance resolution, it will be displayed an error message.  
To escape without inserting the weight press **ON/OFF**.
5. If the weight is enough then “**0**” is displayed ; it is now possible to go on to count loading the pieces on the pan.
6. Press **MENU** button to display the total number of pieces, then press again the button to display again the number of pieces.
7. To escape from piececounting function, press **ON/OFF** button.

It is possible to use the optional alphanumeric keyboard to insert the weight of the unit sample as following:

1. From zero condition on display, press the **MENU** button until the message “**Count**”, then press the **PRINT** button to confirm.  
Select **MANUAL** by pressing repeatedly the **MENU** button.

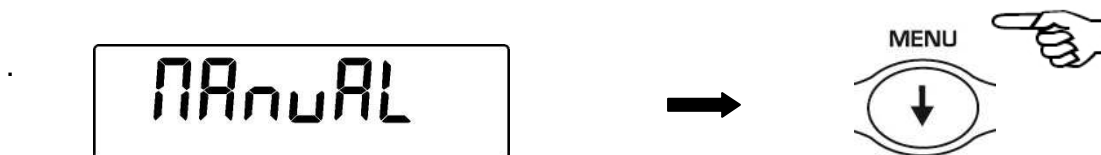

2. Press the **PRINT** button to confirm.
3. Insert the unit weight of a sample in grams using the numerical buttons from 0 to 9 and the decimal point.  
In case of mistake, press the **CLEAR** button to start insertion again.
4. Press the **INSER** button to confirm.
5. If the inserted weight is 100 times lower than balance resolution, it will be displayed an error message.  
To escape without inserting the weight press **ESCAPE** (on alphanumeric keyboard) or **ON/OFF**.
6. If the weight is enough then “**0**” is displayed ; it is now possible to go on to count loading the pieces on the pan.
7. Press **MENU** button to display the total number of pieces, then press again the button to display again the number of pieces.
8. To escape from piececounting function, press **ON/OFF** button.

### 20.3 Automatic update of unit weight

After having effected the sampling, it is possible to update the average piece weight as follows:

1. Instead of loading all the pieces to count, load a number of pieces equal to the double of the ones loaded on the pan and wait for the acoustic alarm.
2. It is now possible to repeat this procedure up to a maximum of 255 pieces or to proceed to the normal counting of the pieces.  
This procedure allows a more accurate evaluation of the average unit weight and a better precision in the pieces count.

**NOTE:** automatic update is not active if the sampling has been effected by insertion of the average unit weight



## 21 Density determination of a solid or a liquid

\* The balance must be equipped with the proper optional software (not available for all models) \*

The software for density determination allows to calculate the density of a solid or a liquid through the under balance hook or through the optional hydrostatic kit

### 21.1 Density determination of a solid

1. From zero condition on display, press the **MENU** button until the message “**dEnS**” is displayed, then press the **PRINT** button to confirm.

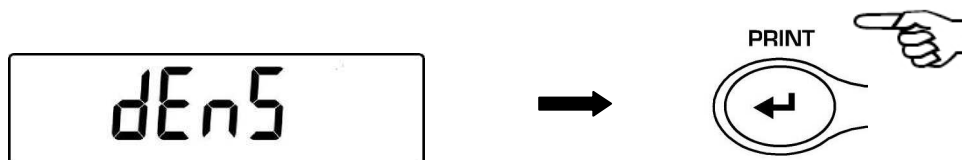

2. Select the function “**d SoLid**” through the MENU button and then confirm with **PRINT** button.

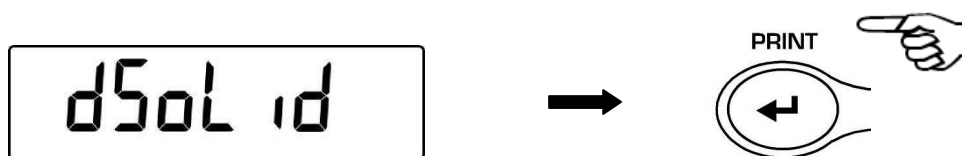

3. The density of the liquid to use will be displayed, the default value is equal to 1.0000 (distilled water at 20°C).

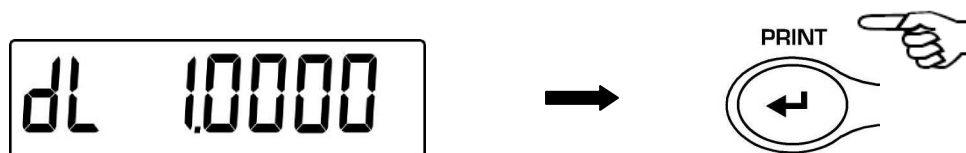

4. It is possible to set a different value using the **CAL** e **MENU** buttons for increase and decrease the value and using the **O/T** button for skip to the others digits. Keeping presses the O/T button is possible to delete the inserted value.

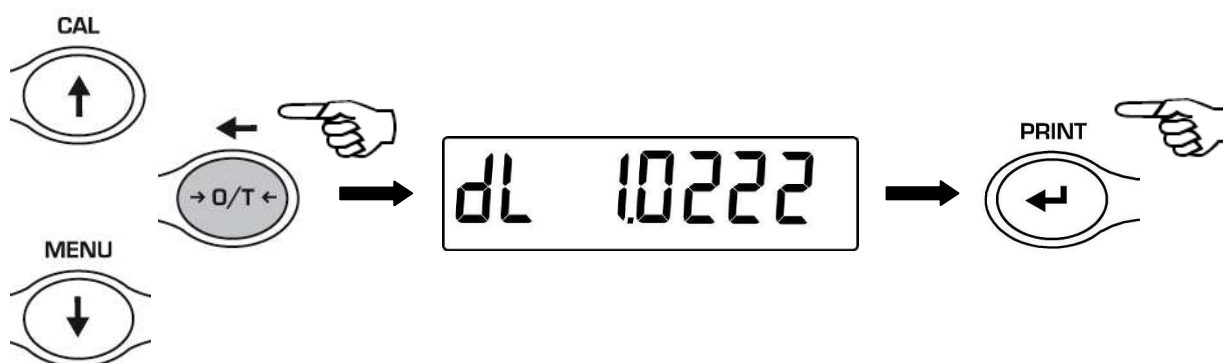

- It is also possible to set a different value if the balance is equipped with the optional alphanumeric keyboard.
- Once the wished value is set, press **PRINT** button.
- Now it will be asked to weigh the solid in air, confirm this with **PRINT** button.



- If necessary, effect a tare operation and load the solid. Press the **PRINT** button to acquire the value. During value acquisition the message **WEI AIR** will be flashing.
- Now it is asked to weigh the solid inside the liquid. Effect the tare of the small basket inside liquid, immerse the solid and press **PRINT**. During the acquisition of the value the message **WEI LIQ** will be flashing.

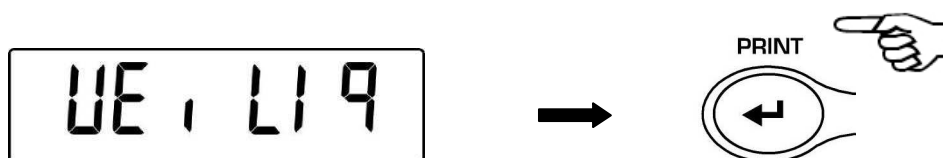

- The result of density of the solid is then displayed. Pressing the **PRINT** button it is possible to print the value of density, if the balance is equipped with a printer.



- If any error occurs, this message will be displayed:

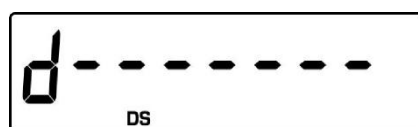

- Press now the **ON/OFF** button to escape from density function or the **MENU** button to perform another measurement.

## 21.2 Density determination of a liquid

1. From zero condition on display, press the **MENU** button until the message “dEnS” is displayed, then press the **PRINT** button to confirm.

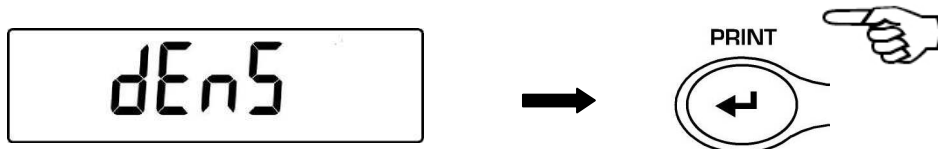

2. Using the **MENU** button, select the function “d Liquid” and confirm this with **PRINT**

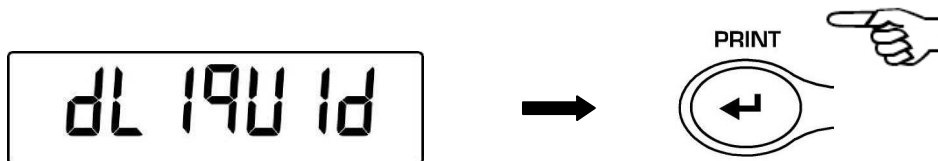

3. It will be displayed the value of the density of the glass float of known volume to use, the default value is equal to 3.0000.

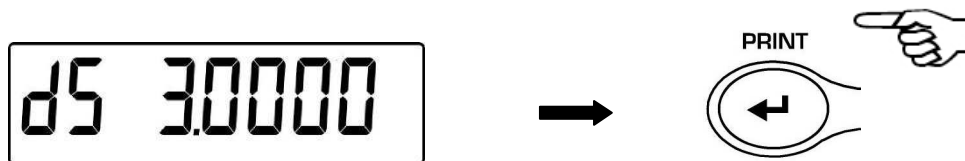

4. It is possible to set a different value using the **CAL** e **MENU** buttons for increase and decrease the value and using the **O/T** button for skip to the others digits. Keeping pressed the **O/T** button is possible to delete the inserted value.

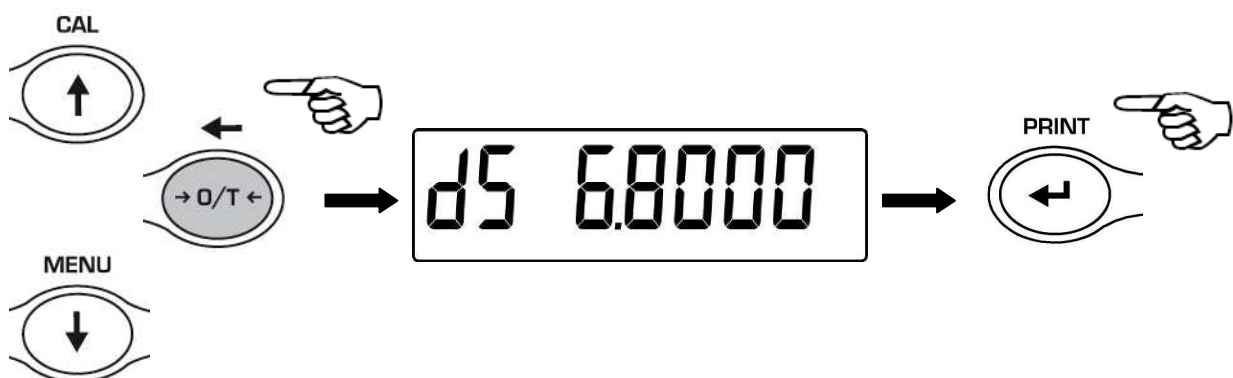

5. It is possible to set a different value if you have the optional alphanumeric keyboard
6. Once the wished value is set, press the **PRINT** button.

7. It is now asked to weigh the glass float in air, confirm this with **PRINT**

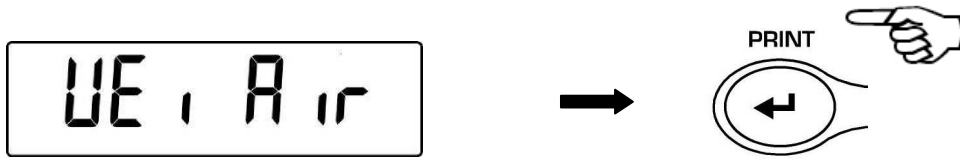

8. Now perform a tare if necessary and put the glass float to the weighing hook. Press then the **PRINT** button to acquire the value. During the acquisition of the value the message **WEI AIR** will be flashing.

9. It is now asked to weigh the glass float immersed into the liquid. Perform a tare if necessary and immerse the glass float into the liquid. Press the **PRINT** button. During the acquisition of the value the message **WEI LIQ** will be flashing.

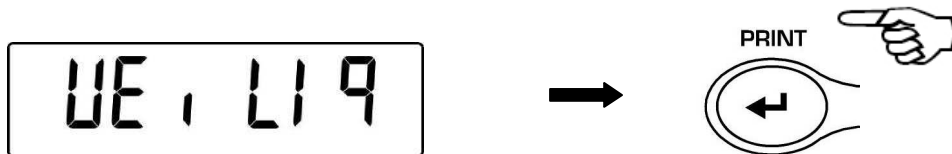

10. The result of the density of the liquid is now displayed. Pressing the **PRINT** button it is possible to print the value of density, if the balance is equipped with a printer.



11. In case of error the following message is displayed

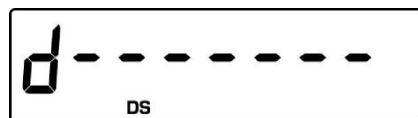

12. Press the **ON/OFF** button to escape from density function, or the **MENU** button to perform another measurement.

## 22 Maximum load determination function

\*The balance must be equipped with the specific optional software (non available for all models)\*

The function **M LOAD** allows to measure the maximum load for a solid.

1. To activate the function M LOAD from zero display condition, press repeatedly the **MENU** button until the message “**M Load**” is displayed, then press the **PRINT** button to confirm. When this function is activated, a tare is automatically performed.



2. Activation of this function is indicated by the visualization of the letter **M** on the last digit on the display.



3. It is now possible to determine the weight of the maximum load.



4. Then press the **TARE** button to effect another measurement.

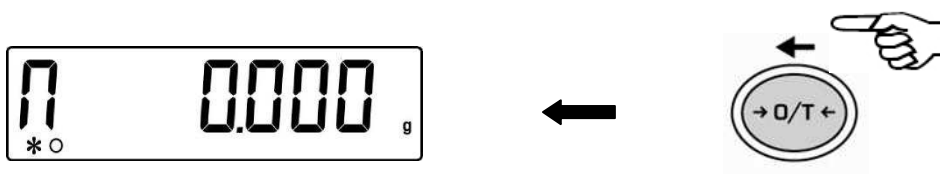

5. When the function **M LOAD** is active, the calibration is disabled.
6. Press the button **ON/OFF** to escape from **M LOAD** function.

## 23 Percentage weighing function

This function allow to read the weighing value as a percentage of a reference weight. The reference weight is took as 100% percentage value (factory setting). There are two mode for acquiring the reference weight: one is automatic (with the reference weight) and one manual (by inserting manually the value of the reference weight).

### 23.1 Mode with weight reference

1. From zero condition of the display press the **MENU** button until will be displayed the “Perc” message, then press the **PRINT** button to confirm.



2. Press the MENU button to select the “Perc A” function and press **PRINT** button to confirm.



3. Tare function will be performed and will be shown on the display the string “Load”. Then load on the weighing pan the reference and press the **PRINT** button, the string “Load” will start to flash and once the weight is acquired will be visualized the value with the % indication.

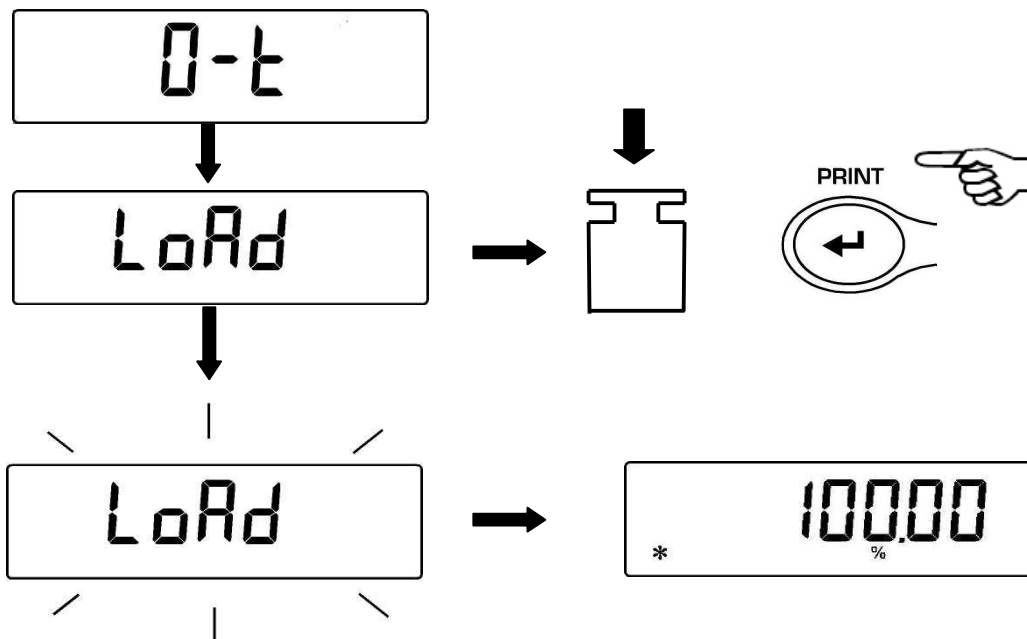

4. Remove now the reference weight and load the sample. Is possible to read the weight in percentage now.

5. Press the **MENU** button to visualize the weight in gram and vice-versa.

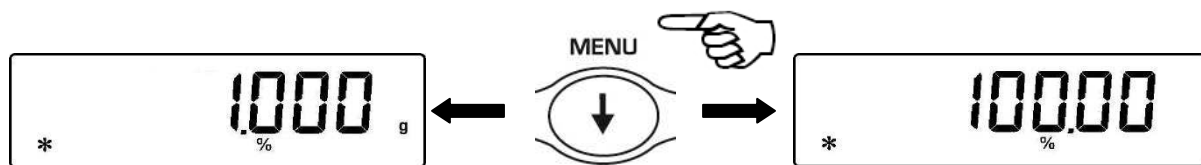

6. Press the **ON/OFF** button to escape from the percentage weight function.

**NOTE:** If the reference weight is lower than 10 digits after the acquiring sequence of the weight, the string **ERROR 07** will be displayed.

### 23.2 Mode with manual insertion of the reference weight.

1. From zero condition of the display press the **MENU** button until will be displayed the **“Perc”** message, then press the **PRINT** button to confirm.



2. Press the **MENU** button to select the **“Perc A”** function and press **PRINT** button to confirm.



3. It is possible to set a different value using the **CAL** e **MENU** buttons for increase and decrease the value and using the **O/T** button for skip to the others digits. Keeping pressed the **O/T** button is possible to delete the inserted value. The inserted value will be stored in the memory until the balance is switched off.

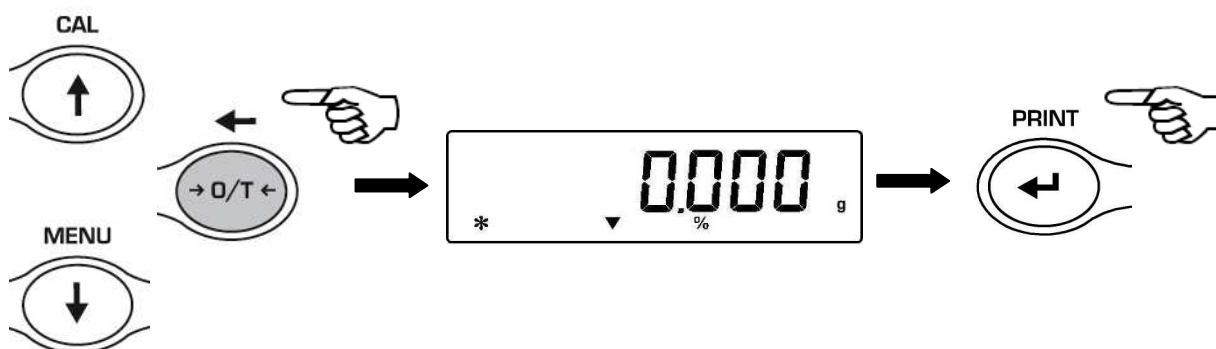

4. Press **PRINT** button when the desired value of the reference weight is inserted
5. Load now the sample and read the percentage value.



6. Press the **MENU** button to visualize the weight in gram and vice-versa.

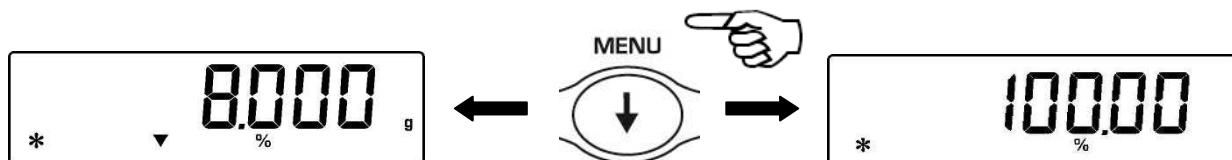

7. Press the **ON/OFF** button to escape from the percentage weight function.
8. It is also possible to set the value if the balance is equipped with the optional alphanumeric keyboard. Press **PRINT** button to confirm the inserted value.

**NOTE:** If the reference weight inserted is lower than 10 digit displayed, will be shown the **ERROR 07**.



## 24 Animal weighing function

This function allows to acquire the averaged weight of moving objects or animals for a time period that can be set.

1. From zero condition of the display press the **MENU** button until will be displayed the “anim UEi” message, then press the **PRINT** button to confirm.

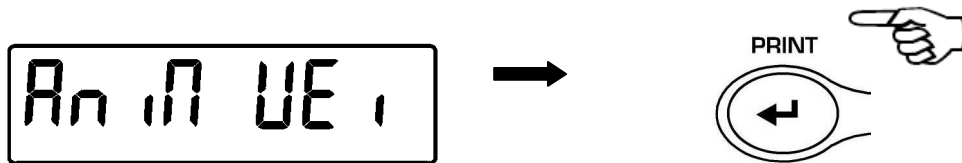

2. Set the desired period time from 5 to 90 sec. using the button **MENU** to decrement and **CAL** to increment time. Confirm by pressing the **PRINT** button.

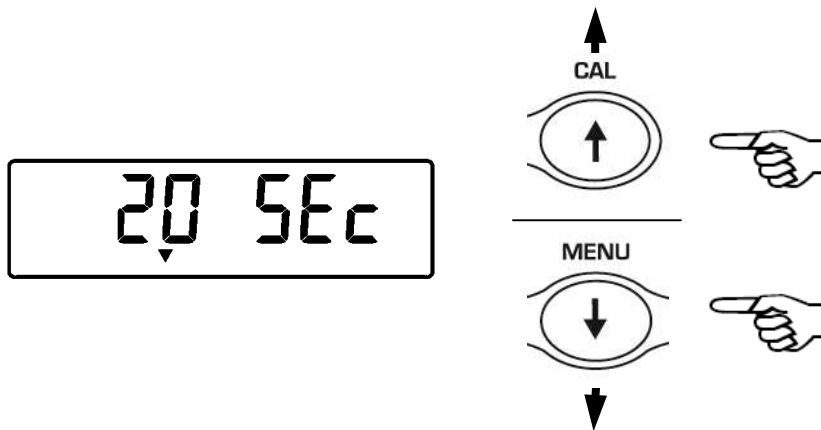

3. It is now displayed the value of current weight, effect tare if necessary, then load on the pan the sample to weight and press the **PRINT** button

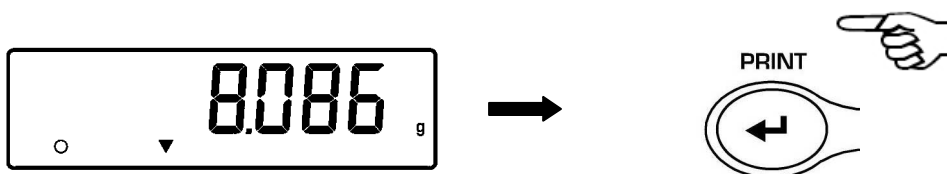

4. It is then displayed the count-down of the sampling time value that has been previously set.
5. When the count-down is finished, it is calculated and then displayed the value of the averaged weight measured.

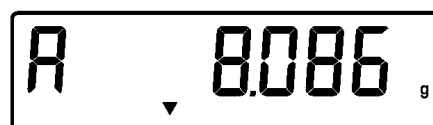

6. Press once the **ON/OFF** button to start another measurement, or twice to escape this function and return to weighing mode

## 25 Totalizing

This function allows to effect sum of consecutive weighings.

1. From zero condition of the display press repeatedly the **MENU** button until will be displayed the “**add**” message, then press the **PRINT** button to confirm.

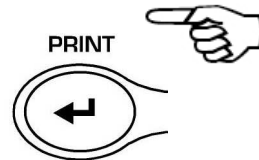

2. The Tare is automatically effected.



3. Load the first weight to sum.

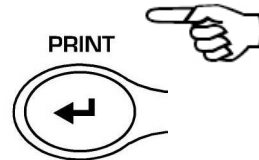

4. Confirm with the **PRINT** button.
5. The Tare is again effected.

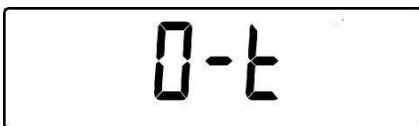

6. Load the second weight to sum.

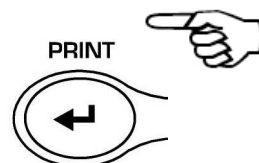
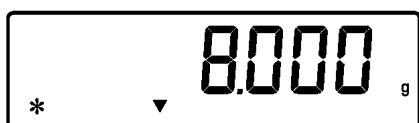

7. Confirm with the **PRINT** button. Follow all the above steps for all weights to sum up to a maximum number of 99.
8. Pressing the **MENU** button it is possible to show in sequence the informations respectively of total weight, number of weighings effected and current weight.

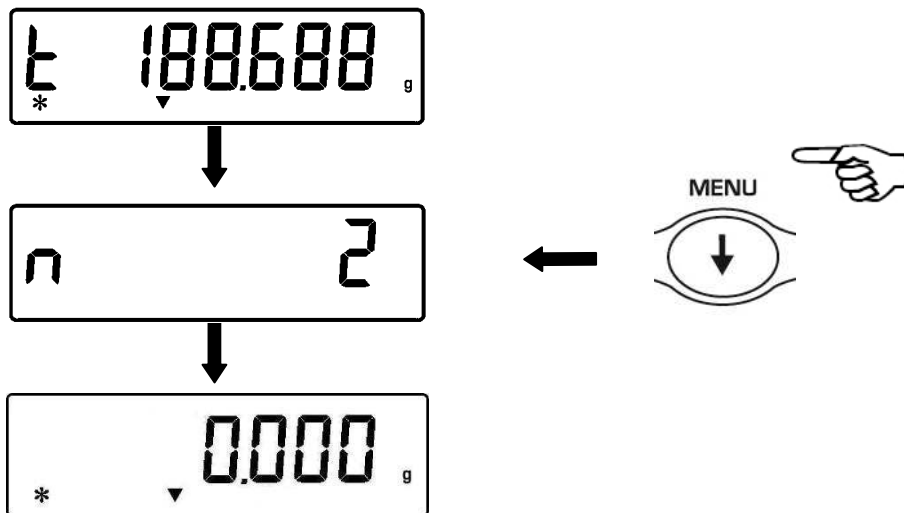

Before the output function:

If the balance is equipped with a printer or connected to a PC, automatically after pressing the print button, will be printed or sent to PC the weigh number and its value. After running all the desired weighs, press CAL to print or send to the PC the value of the total weight. The count of the weighings will then be reset and it will be possible to start over a new measure.

Press the **ON/OFF** button to escape this function and return to weighing mod

## 26 Threshold function

Threshold function allow to determinate if the weight loaded on the pan is above or below the two threshold fixed by the user.

1. From zero condition of the display press the **MENU** button until will be displayed the string “**H o L**”, then press the **PRINT** button to confirm.

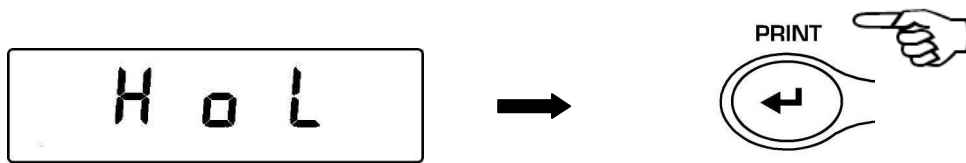

2. Insert the lower threshold value using the **CAL** e **MENU** buttons for increase and decrease the value and using the **O/T** button for skip to the others digits. Keeping pressed the **O/T** button is possible to delete the inserted value. The inserted value will be stored in the memory until the balance is switched off.

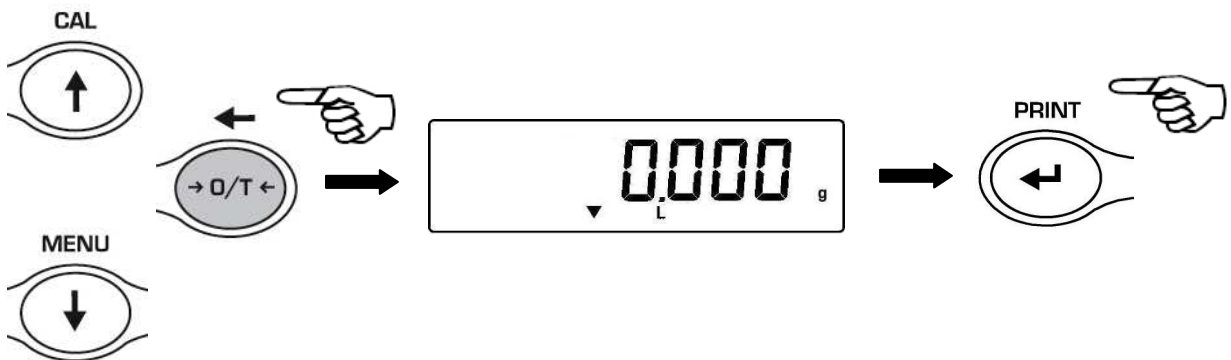

3. Insert the higher threshold value as same as the lower value steps.
4. The string “**bEEP OFF**” will be displayed and select by the **MENU** button if the acoustic alarm should be set or not if the weight is within the two threshold values set before. Press **PRINT** button to confirm.

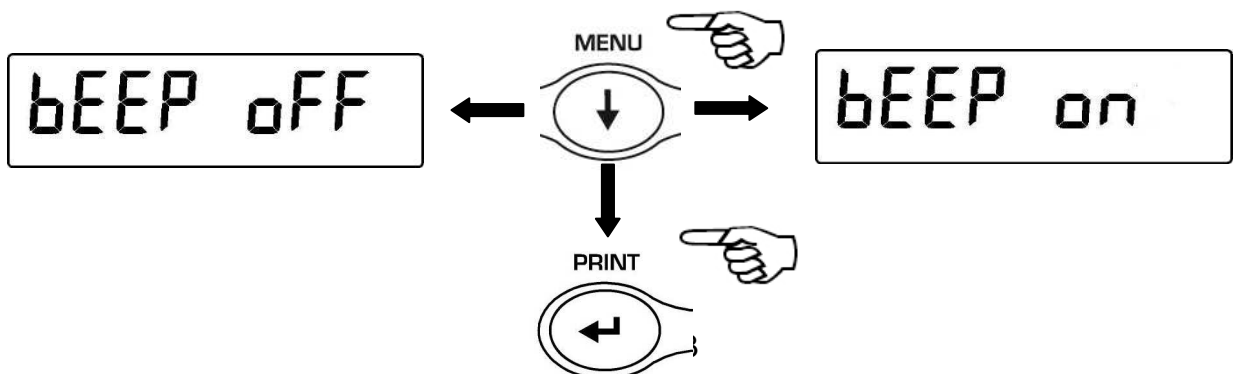

5. If the value of the thresholds is correctly inserted, the balance will be back to the weighing mode with the indication of the threshold state (H = higher threshold, L = lower threshold, OK= weight within the two set thresholds).

**NOTE: If the values are not inserted correctly will be displayed the string ERROR 07.**

There are 3 modes of the threshold function:

### **26.1 Both thresholds set**

This mode allow to set the lower and the higher threshold values and to identify the acceptable range for the weight value shown by the switching on of the symbol "OK" and by the acoustic alarm is activated. When the value of the weight is under the lower threshold value set will be displayed the symbol " L " while if the weight is over the higher threshold value set will be displayed the symbol " H " .

### **26.2 Lower threshold set only**

Setting only the lower threshold and setting to zero the higher threshold, will be displayed the symbol "OK" and eventually the acoustic alarm if activated whenever the loaded weight is higher than the lower threshold value set. When the value of the weight is under the lower threshold set the symbol " L " will be displayed.

### **26.3 Higher threshold set only**

Setting only the higher threshold and setting to zero the lower threshold, will be displayed the symbol "OK" and eventually the acoustic alarm if activated whenever the loaded weight is lower than the higher threshold value set. When the value of the weight is above the higher threshold set the symbol " H " will be displayed.

## 27 RS232 interface features

### 1. General features

The balance transmits the value visualized on the display following serial RS232C standard, allowing to print the value of weight to a PC monitor or to a serial printer. In the case of connection to a PC, it will be possible to select the transmission in continuous mode or transmission at user command through pressing of the **PRINT** button ( as described at par.0 ). The balance is also capable of receiving commands, always through the standard RS232C, that allow to perform all the functions available through the keyboard of PC itself. The speed of transmission and reception can be selected, as described previously (see par. 0), to 1200, 2400, 4800, e 9600 baud. The character format is of 8 bit preceded by one bit of start and followed by a bit of stop. Parity is not considered.

### 2. Selection of interface for PC

Selecting the transmission to PC (personal computer IBM compatible), it is achieved a continuous transmission output, at the same rate of weight update on display of the balance. It is possible to perform all the functions of the balances directly from the computer keyboard, transmitting to the balance the ASCII codes as in the table below. The connector to use for connection to PC is the number 4 in fig.1 of par. 0

CODE	1 <sup>st</sup> FUNCTION (SINGLE PRESS)
"T" = H54	TARE
"C" = H43	CALIBRATION
"E" = H45	ENTER
"M" = H4D	MENU
"O" = H4F	ON/OFF

CODICE	2 <sup>nd</sup> FUNCTION (PROLONGED PRESS)
"t" = H74	TARE
"c" = H63	CALIBRATION
"e" = H65	ENTER
"m" = H6D	MENU
"o" = H6F	ON/OFF

Selecting the transmission to PC at user command, it is achieved a transmission output only when the **PRINT** button is pressed, also in this case it is possible to perform all the functions of the balance directly from the keyboard of the computer, sending to the balance the ASCII codes in the table above. The connector to use for connection to PC is the is the number 4 in fig.1 of par. 0

### 3. Connection of the balance to PC

To receive/transmit data, connect the connector (number 4 in fig.1 of par. 0) of the balance to the serial port of the PC as shown below:

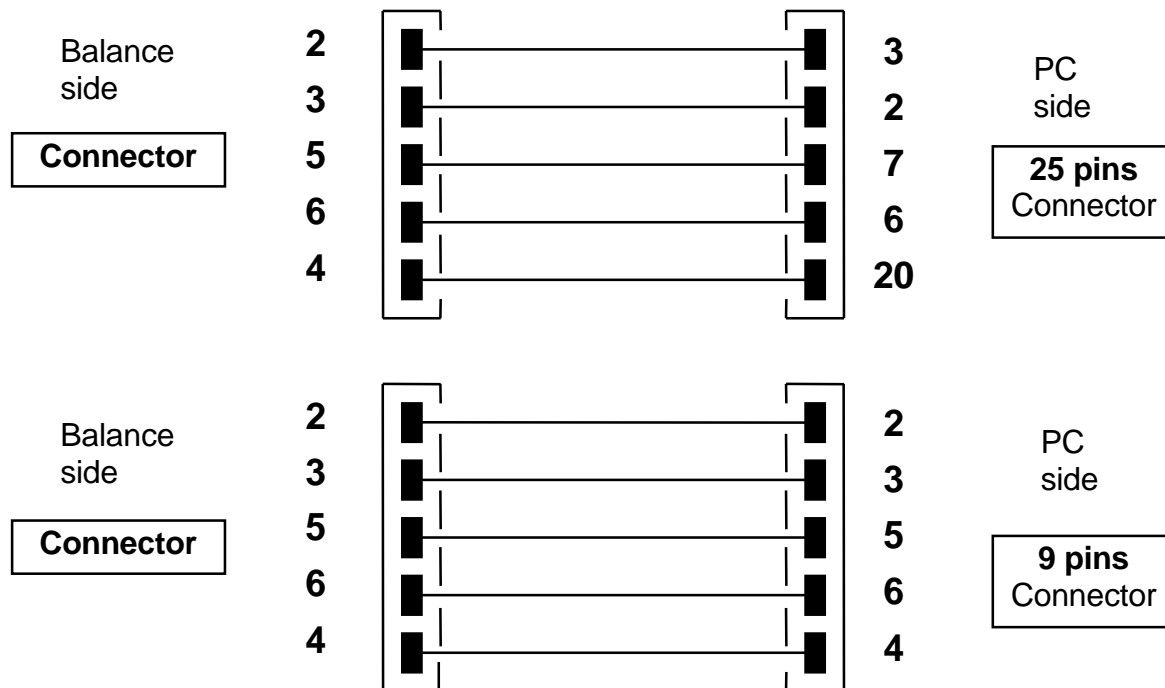

### 4. Transmission format

String transmitted is composed by the following 14 characters:

- First character: weight sign (blank or -)
- second/ninth character: weight or other data
- tenth/twelfth character: weight unit symbol
- thirteenth character: stability indicator (only for continuous transmission)
- fourteenth character: carriage return
- fifteenth character: line feed

Eventually non-significative zero are spaces.

In the following tables the various transmission formats are shown:

Weighing mode (valid both for continuous transmission and transmission at user command)

1°	2°	3°	4°	5°	6°	7°	8°	9°	10°	11°	12°	13°	14°	15°
Sign	Weight								Weight unit			Stability*	CR	LF

\*only for continuous transmission

Density mode (only in transmission at user command mode)

1°	2°	3°	4°	5°	6°	7°	8°	9°	10°	11°	12°	13°	14°	15°	16°	17°
----	----	----	----	----	----	----	----	----	-----	-----	-----	-----	-----	-----	-----	-----

d	=	Density value	Space	Weight unit	CR	LF
---	---	---------------	-------	-------------	----	----

Piececounting mode (only in transmission at user command mode)

Number of pieces

1°	2°	3°	4°	5°	6°	7°	8°	9°	10°	11°	12°	13°	14°	15°	16°	
Pcs		:	spaces					Number of pieces								

Total weight of pieces

1°	2°	3°	4°	5°	6°	7°	8°	9°	10°	11°	12°	13°	14°	15°	16°	17°	18°	19°	20°
Weight							:	space	Value of weight							space	g	space	S

Average unit weight of pieces:

1°	2°	3°	4°	5°	6°	7°	8°	9°	10°	11°	12°	13°	14°	15°	16°	17°	18°	
PMU		:	spaces					Value of weight									spaces	g

Percentage weight mode (only in transmission at user command mode)

Percentage

1°	2°	3°	4°	5°	6°	7°	8°	9°	10°	11°	12°	13°	14°	15°	16°	17°	18°
Perc			.	space				Percentage								space	%

Weight

1°	2°	3°	4°	5°	6°	7°	8°	9°	10°	11°	12°	13°	14°	15°	16°	17°	18°
Weight						space		Weight value							space	g	

Animal weighing mode (only in transmission at user command mode)

Time

1°	2°	3°	4°	5°	6°	7°	8°	9°	10°	11°	12°	13°	14°	15°	16°	17°	18°
----	----	----	----	----	----	----	----	----	-----	-----	-----	-----	-----	-----	-----	-----	-----



Time	space	=	space	Time value	Sec	space
------	-------	---	-------	------------	-----	-------

Averaged Weight

1°	2°	3°	4°	5°	6°	7°	8°	9°	10°	11°	12°	13°	14°	15°	16°	17°	18°
Ave		.	=	space				Averaged weight value				space	g				

Totalizing (only in transmission at user command mode)

Weighing

1°	2°	3°	4°	5°	6°	7°	8°	9°	10°	11°	12°	13°	14°	15°	16°	17°	18°
Weighing number		.	space			Value of weight						space	g				

Weighs total

1°	2°	3°	4°	5°	6°	7°	8°	9°	10°	11°	12°	13°	14°	15°	16°	17°	18°
S	space	=	space			Value of weight						space	g				

Threshold function (only in transmission at user command mode)

1°	2°	3°	4°	5°	6°	7°	8°	9°	10°	11°	12°	13°	14°	15°	16°	17°	18°	19°	20°
Weight						:	minus sing if negative	Value of weight						space	g				

If Low

1°	2°	3°	4°	5°
- Low -				

Else Hight

1°	2°	3°	4°	5°
- Low -				

Else Ok

1°	2°	3°	4°	5°
- Ok -				

## 5. Selection of interface to printer

Selecting the PRINTER mode, the serial output of the balance is set to work with serial printers.

In this case the printing is effected only when the **PRINT** button is pressed and with stable weight. If the stability is not reached within ten seconds, the message **ERROR05** is displayed preceded by a short acoustic signal and the value of the weight is not sent to the printer.

The connector to be used for the connection is the number 4 shown in fig.1 of par. 0

## 6. Connection of the balance with the serial printer

Connect a serial printer to connector 1 to the balance as shown in the following scheme:

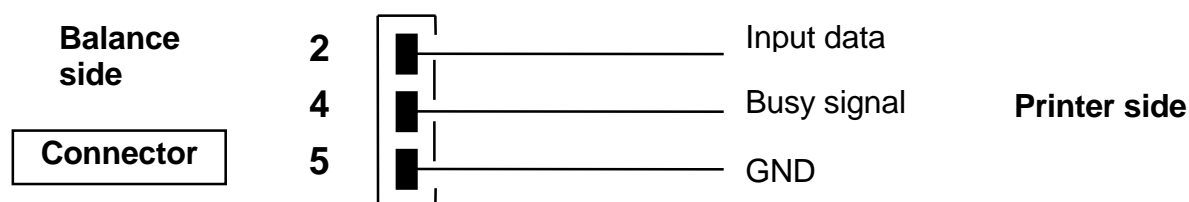

If the optional TLP50 printer is used, it will be possible to print both in *continuous-mode* and in *labels-mode* with the following formats:

### Weighing mode and maximum load mode

12-02-2008	12:00
Weight:	22.000 g

### Piececounting mode

12-02-2008	12:00
Pcs	100
Weight:	300.000 g
PMU:	3.000 g

### Density determination mode

12-02-2008	12:00
d=	2.80066 g/cm <sup>3</sup> d

### Percentage weight mode

12-02-2009	12:00
Perc.	100.0%
Weight:	300.000 g

### Animal weighing mode

12-02-2010	12:00
Time =	6 Sec
Ave. =	59.446 g

### Totalizing (sum of weights) mode

12-02-2009	12:00
1.	16.589 g
2.	17.226 g
...	
99.	
-----	
S=	33.815 g

12-02-2013 12:00  
Weight: 0.00g  
-LOW-

12-02-2012 12:00  
Weight: 49.20g  
- OK -

12-02-2011 12:00  
Weight : 249.42g  
-HIGH-

### 7. Connection of the balance to the optional alphanumeric keyboard

To connect the optional alphanumeric keyboard it must be used the connector number 4 shown in fig.1 of par. 0 (the same used for connection to a PC). In this case the connection to PC or to printer must be effected through the connector placed on the optional alphanumeric keyboard.

### 8. Map of RS232 interface (Indicated to par 0, Fig.2)

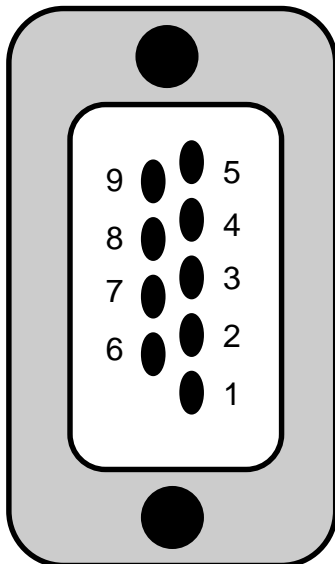

Fig. 2

### CONNECTOR MAP (CONNECTION FOR KEYPAD, PC AND PRINTER)

- pin 1 = Power +5V for keyboard
- pin 2 = Tx signal
- pin 3 = Rx signal
- pin 4 = busy signal
- pin 5 = Gnd
- pin 4-6 = connected to each other for connection to PC

Fig. 3

## 28 Working with battery

Balance can work, at wish, using only the battery power.

The battery on board is located inside the balance and grants 10 hours of autonomy

1. With the external power supply disconnected, it is possible to switch on or switch off the balance trough the **ON/OFF** button and work without being connected to power AC outlet.
2. When the balance is working using the battery, the symbol of battery with charge level is displayed on up-right corner of the balance's display. The three lines all switched on means a maximum level of battery charge, instead when all three lines are switched off and only the battery symbol is displayed means that it is necessary to connect the balance to AC power outlet to re-charge the battery.

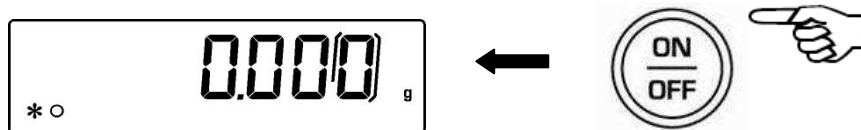

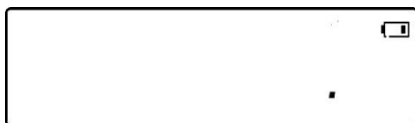

3. To re-charge the battery, connect the provided external power supply to the balance. (see par.5)
4. When the external power supply is connected, the balance automatically switch itself on and, after performing the initial test on display, it enters the stand-by mode showed by a single point in the display. In standby mode also the battery recharge symbol will remain switched on.



5. The charge level will step by step raise until it reaches the maximum level. However let the battery recharge at least for 8-10 hours before disconnecting the external power supply from the balance.

NOTE: Battery duration depends also from working mode of the display backlight. To get a longer battery duration, switch off the backlight or set it in AUTO mode.

## 29 Error Codes

ERROR MESSAGE ON DISPLAY	MEANING	POSSIBLE SOLUTIONS
ERR01	Weight not stable after operation of tare	Protect the balance from air flows or from vibrations of the working table
ERR02	impossible to start the calibration due to instability of the balance	Protect the balance from air flows or from vibrations of the working table.
ERR03	calibration weight not correct or balance unstable	Calibrate with correct weight or protect the balance from environment disturbs
ERR04	weight of samples for the piececounting function not adequate or unstable	Select a bigger number of samples or protect the balance from vibrations.
ERR05	impossible to print / weight unstable	Protect the balance from environment disturbs
ERR06	Weight cannot get stable in density mode	Protect the balance from environment disturbs
ERR07	error in inserting the data	
	Over-range condition	Unload the weights loaded on the pan
	Under-range condition	Place properly pan and underpan

## 30 Maintenance and care

Regular maintenance of yours balance guarantee accurate measurements.

- **Cleaning**

Before cleaning the balance unplug the power supply of the balance from the voltage supply of your room. Do not use aggressive cleaning product (as solvents or similar), use a humid towel with soft detergent, Avoid liquids to go inside the instruments during the cleaning. Wipe the balance with a soft towel. Parts of samples or powder can be removed using a brush or vacuum cleaner.

- **Safety checks**

Safety of the instrument is no more guaranteed when:

-balance power supply is clearly damaged

-balance power supply is not working anymore

-balance power supply is stored for long time in hard environment conditions.

In these instances refer to the assistance centre where specialized technician will make reparations to bring back the instrument in the safety conditions eventually.

## 31 Quick guide to balance parameters setup

- To enter the balance parameters setup menu, press and keep pressed the **MENU** button until the acoustic alarm is over.
- Use then the **MENU** button to go to next parameter, use the **CAL** button to go to previous and the **PRINT** button to confirm the choice.
- To escape from menu, press the and keep pressed the **MENU** button until the acoustic alarm is over.

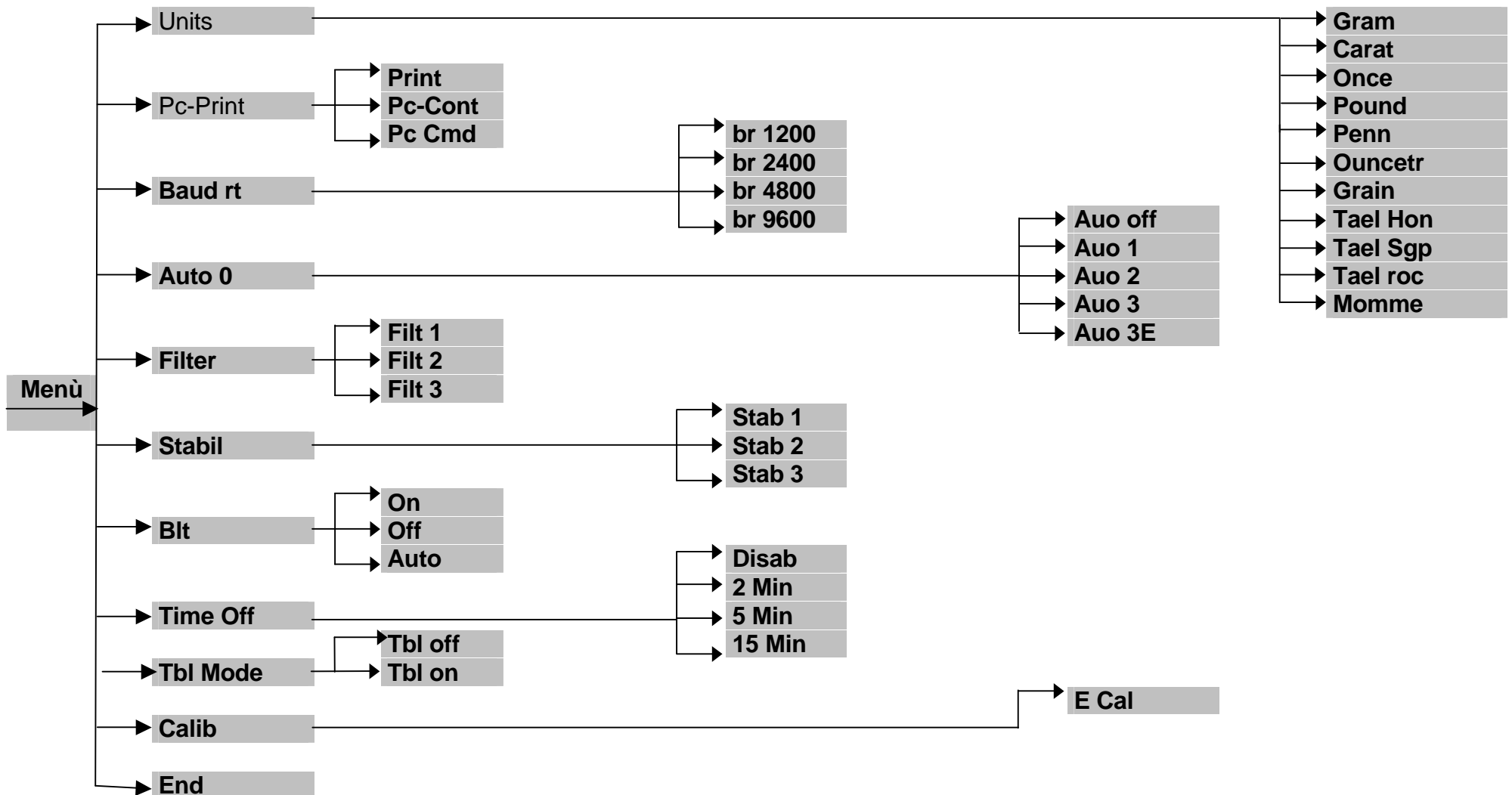

## 32 Quick guide to the use of the balance programs

- To enter the balance programs menu, press the **MENU** button.
- Use then the **MENU** button to go to next parameter, use the **CAL** button to go to previous and the **PRINT** button to confirm the choice.
- To escape from menu, press the and keep pressed the **MENU** button until the acoustic alarm is over.

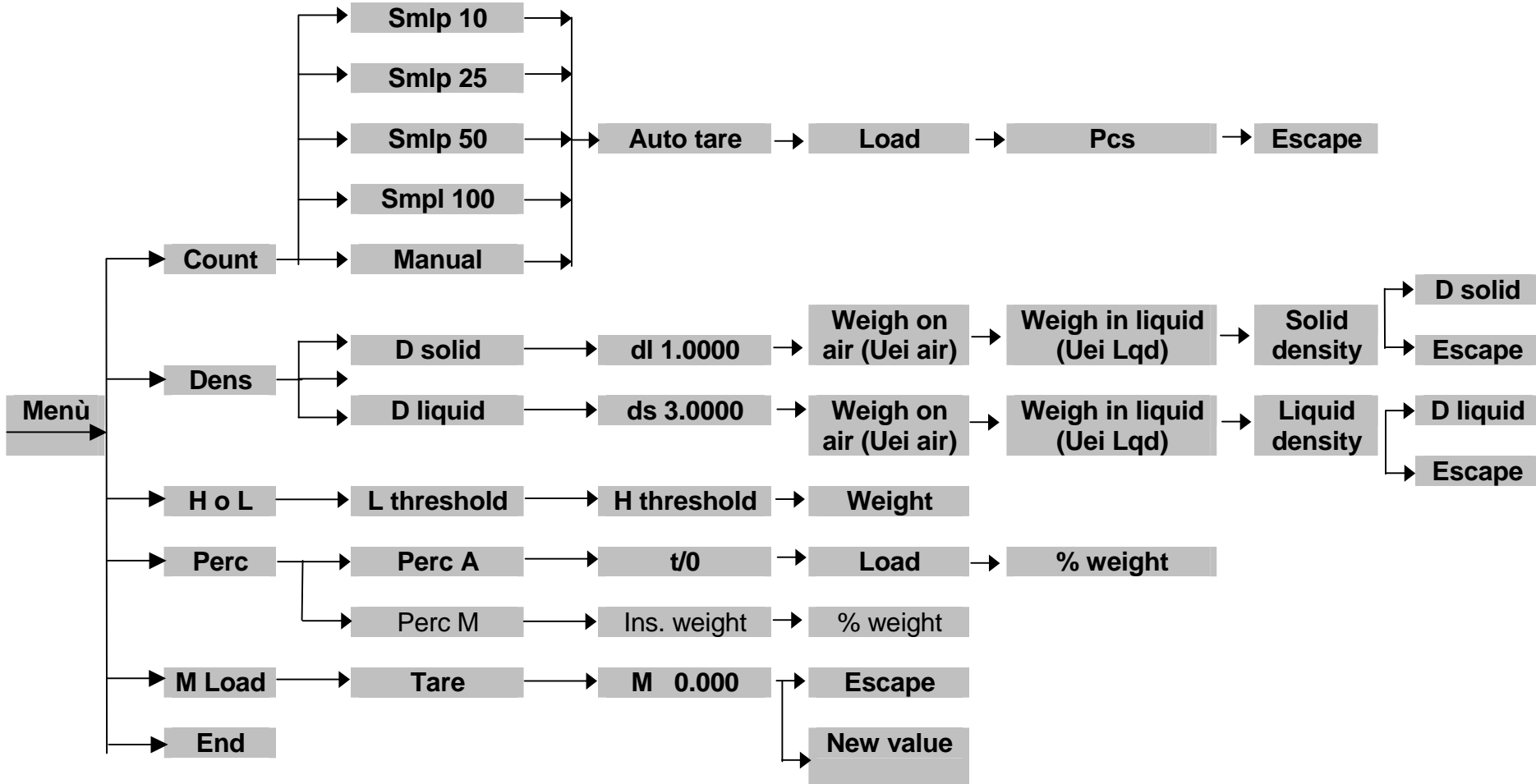



### 33 Balance technical features

#### Balances Series Mark S

The models below indicated are all for internal use. Max altitude use: 4000m; Pollution grade: 2; Overvoltage category: II

Power supply included:	INPUT: Switching 100-240Vac~ 50/ 60Hz, OUTPUT: 9V DC 1000mA, Max absorbed power 9VA
Battery:	internal rechargeable
Environment condition adaption:	Selectable filters
Autozero:	Selectable from Menu
Serial output:	RS232C
Operating temperature range:	+5°C - +35°C

## 34 Warranty

- Duration of warranty is of 24 months from the date of purchase proved by invoice concerning the product or by delivery note.
- Warranty covers all parts resulting defective at the origin. It does not cover mechanical or electronic parts damaged by wrong installation, tampering or incorrect use.
- Warranty does not cover damages caused by impacts, balance drops or drop of objects on weighing pan.
- Shipment to and from service centre is at customer charge.

## 35 Equipment disposal



This equipment is marked with the crossed out wheeled bin symbol to indicate that this equipment must not be disposed of with unsorted waste.

Instead it's your responsibility to correctly dispose of your equipment at lifecycle -end by handling it over to an authorized facility for separate collection and recycling. It's also your responsibility to decontaminate the equipment in case of biological, chemical and/or radiological contamination, so as to protect from health hazards the persons involved in the disposal and recycling of the equipment.

For more information about where you can drop off your waste of equipment, please contact your local dealer from whom you originally purchased this equipment.

By doing so, you will help to conserve natural and environmental resources and you will ensure that your equipment is recycled in a manner that protects human health.

Thank you